

# ROLL2BASKET - Belt Tape Device

## User Manual

### Installation and Operating

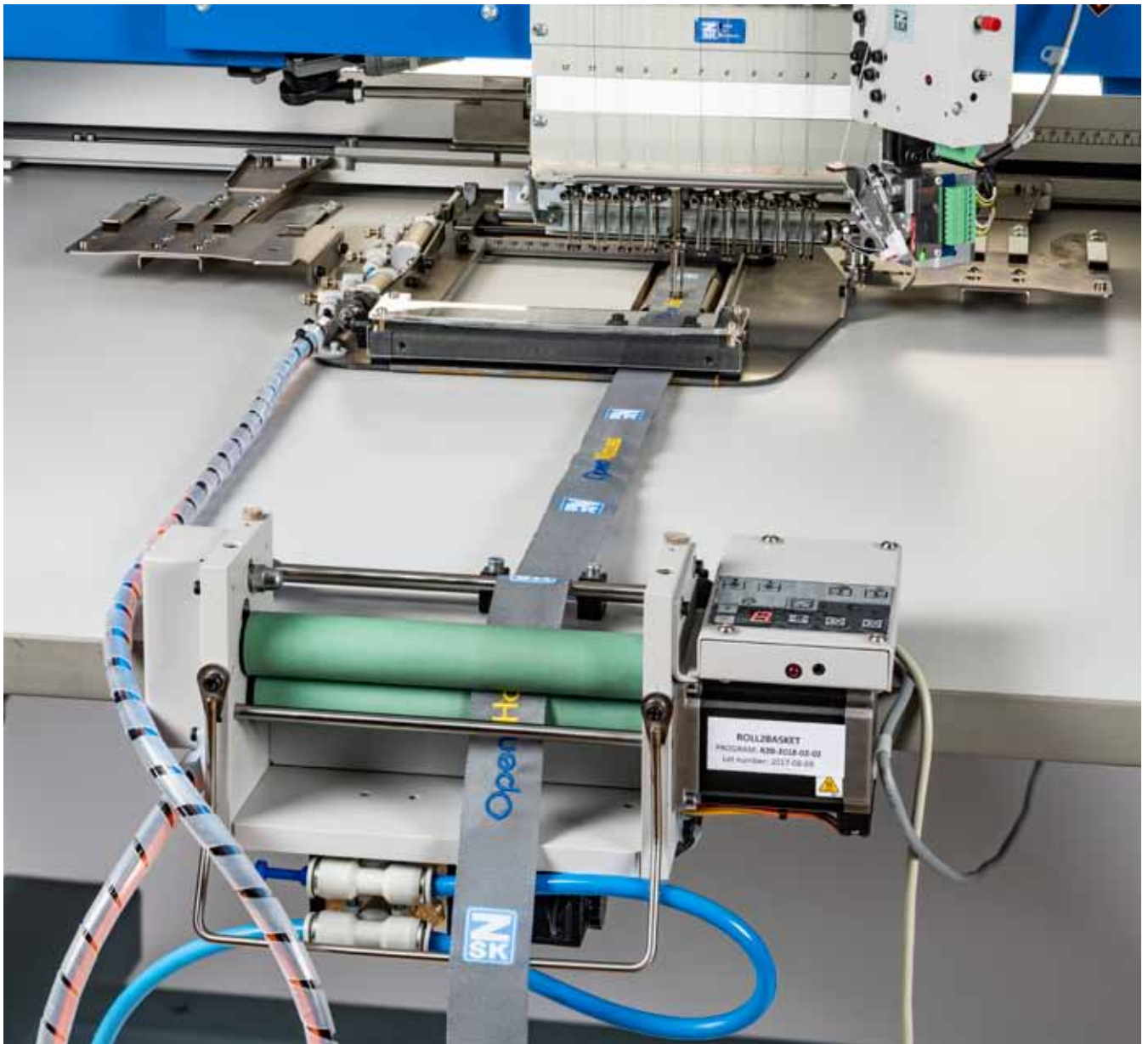

# 1. FOREWORD

This manual is a guidebook for using the BELT TAPE DEVICE "ROLL2BASKET" correctly. Assembling and adjustment of the device and items to notice when using the device are described in this manual. Please read this manual thoroughly and use the device after understanding the contents.

This manual may contain discrepancies in detailed information when compared with the actual product due to continued research and improvements. If any question about the product or the contents of this manual arises, please consult your ZSK distributor.

Please keep this manual near the machine for immediate reference.

## Content

1. FOREWORDe .....	2
2. IMPORTANT SAFETY INSTRUCTIONS.....	4
3. DESCRIPTION OF GENERAL PURPOSE .....	6
4. COMPLETE SET - HOOP & TAPE CONTROL.....	8
4.1 COMPLETE SET- ELECTRICAL PARTS .....	9
5.1 PREPARING THE PNEUMATIC HOOP .....	10
5.2 OPERATION WITH THE CONTROL PANEL. ....	15
5.3 EMBROIDERY. EMBROIDERY FEATURES. ....	20
5.4 TIPS FOR CREATING EMBROIDERY DESIGNS .....	22
6.1 ELECTRICAL INSTALLATION.....	24
6.2 ELECTRICAL INSTALLATION.....	33
6.3 PNEUMATIC INSTALLATION .....	37
6.4 Tape Holder Assembly.....	40
6.5 CALIBRATION- PROXIMITY HALL EFFECT SENSOR .....	44
6.6 TESTING THE FORCE SENSOR.....	46
7.1 DIP SWITCH SETTINGS .....	48
7.2 ROLL2BASKET ERROR MESSAGES .....	49
7.3 Wiring diagram belt tape device "ROLL2BASKET" .....	50
7.4 ROLL2BASKET(Part List).....	51

## 2. IMPORTANT SAFETY INSTRUCTIONS

To use the device safely, it is necessary to handle it correctly. Please read the IMPORTANT SAFETY INSTRUCTIONS described in this manual thoroughly and do not handle this device until you fully understand the contents. Since items to notice when handling this device are described in below signal terms that follow warning marks in this manual, be sure to observe them.

### DEFINITIONS OF SIGNAL TERMS ARE AS FOLLOW:

#### **DANGER**

Safety instructions labelled "Danger" must be observed in order to avoid the risk of personal injury.



This symbol marks instructions in the operator's guide whose infringement can give rise to personal injury or damage to property.



Risk of injury from electric shock.

#### **CAUTION**

Safety instructions labelled "Caution" must be observed in order to avoid the risk of damage to property.



Risk of crushing by moving machine parts.



Risk of piercing by moving mechanical parts (needles, borers).



Risk of burning by hot components (magnets, motors).

#### **NOTE**

Instructions labelled "Note" must be observed to avoid malfunctions/operating errors.

## ITEMS TO NOTICE WHEN USING THE DEVICE

### CAUTION

The device is intended for use only for its intended purpose and in a technically safe and serviceable condition.



Inappropriate use may be danger. Cause physical injury or damage to property.

## SAFETY PRECAUTIONS



To work on the embroidery machine equipped with devices only allowed trained personnel.



Daily visually check the integrity of electrical connections and isolation.



Forbidden to operate in rooms with humidity higher than 95%.



Forbidden to operate with wet hands.



Operator's fingers in the embroidering zone during device operation are forbidden.

### 3. DESCRIPTION OF GENERAL PURPOSE

Belt Tape device «ROLL2BASKET» can be used on the ZSK embroidery machines. Allows embroidery on belts and tapes from 10 mm to 150 mm.

The system can be retrofitted on SPRINT and RACER series which have to have the tubular and table options.

NOTE Install the appropriate software T8/T8-2 Release 27.09.2016

#### GENERAL TECHNICAL SPECIFICATIONS

Tape width	10...150 mm
Tape thickness	0,2...5 mm
Maximum speed	900 st./min
Embroidery field:	150x200 mm
Supply voltage	+24 VDC ( $\pm 10\%$ )
Consumed power	1,5 A
Air pressure	6,0 bar
Size: Pneumatic embroidery hoop:	360x400x26 mm
Weight, net: Pneumatic embroidery hoop:	2900 g
Size: Tape control device:	290x120x120 mm
Weight, net: Tape control device:	4300 g
Total weight, net*	9000 g

\*Weight of the BELT TAPE DEVICE "ROLL2BASKET" without Control Means set parts.



## 4. COMPLETE SET - HOOP & TAPE CONTROL

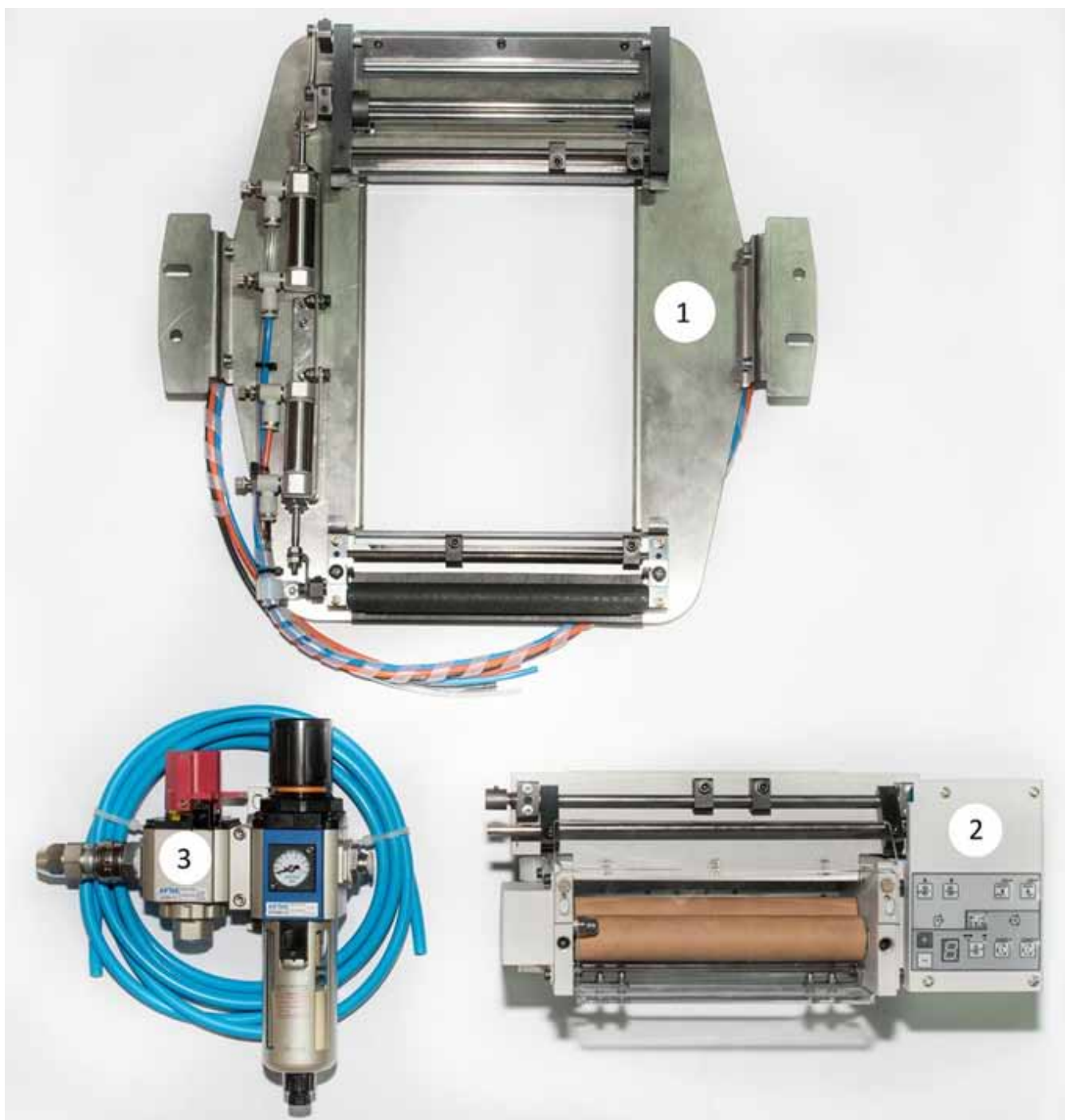

Item No.	Description	Part No.	Qty
1	Pneumatic embroidery hoop	1110 0000	1 pcs
2	Tape control device	1120 0000	1 pcs
3	Air preparation device	1130 0000	1 pcs



## 4.1 COMPLETE SET - ELECTRICAL PARTS

(for connecting the device to the embroidery machine)

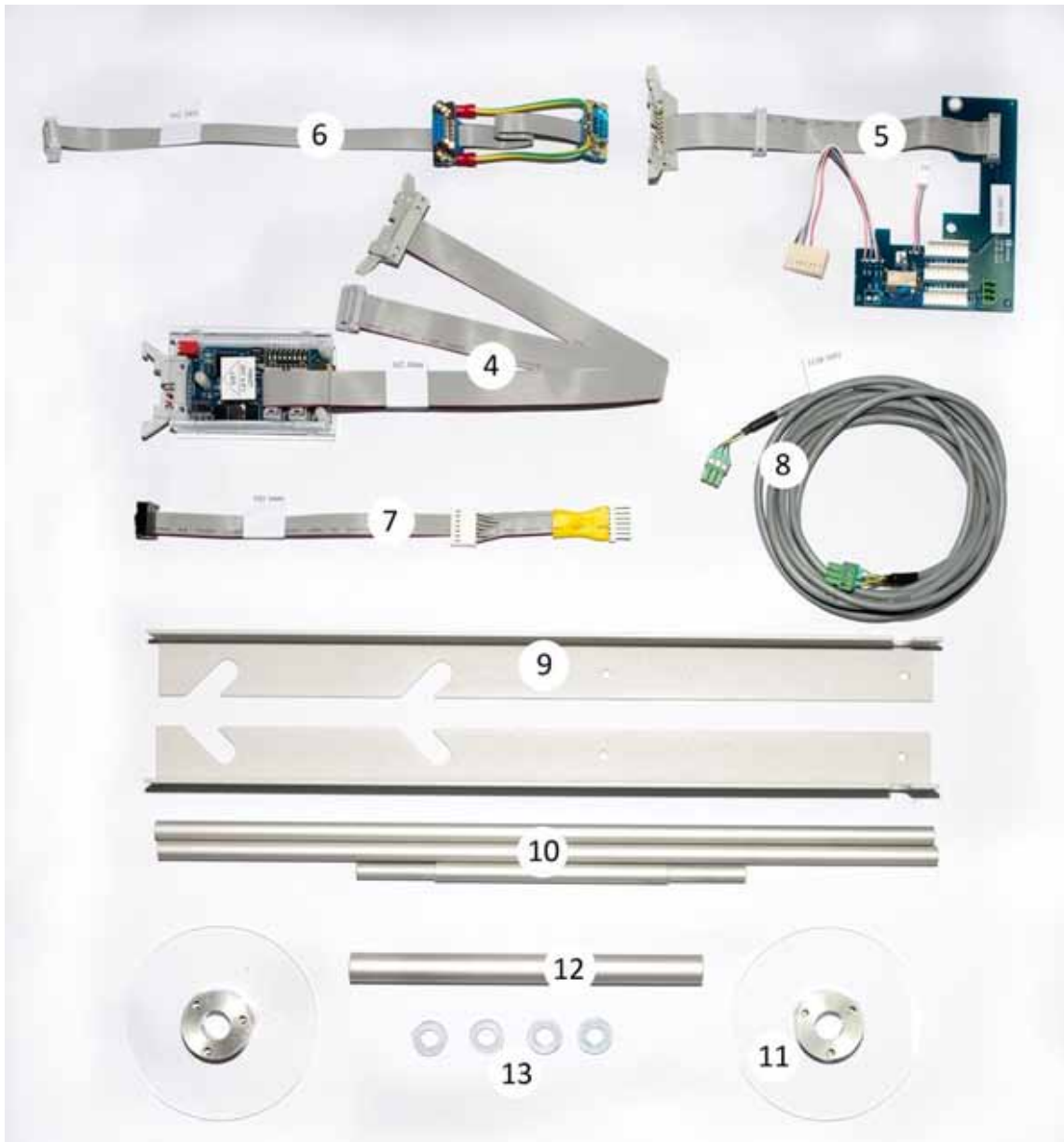

Item No.	Description	Part No.	Qty
4	KSP Bus Controller mini	102 0000	1 pcs
5	Adapter KSP 10	300 000	1 pcs
6	Cable	102 3001	1 pcs
7	Cable	102 3000	1 pcs
8	Cable	1120 3002	1 pcs
9	Holder (Sprint, Racer )		2 pcs
10	Guide rail axle (920mm)		1 set
11	Coil cheek		2 pcs
12	Coil axle		1 pcs
13	Fixing ring		4 pcs

## 5.1 PREPARING THE PNEUMATIC HOOP

LAYING THE TAPE. ADJUSTMENT OF THE PRESSER FOOT.

1. Power off the embroidery machine.



2. To embroider on the tape of a new kind (by width, thickness or structure) place both the tape control device and the pneumatic hoop as shown in the photo.

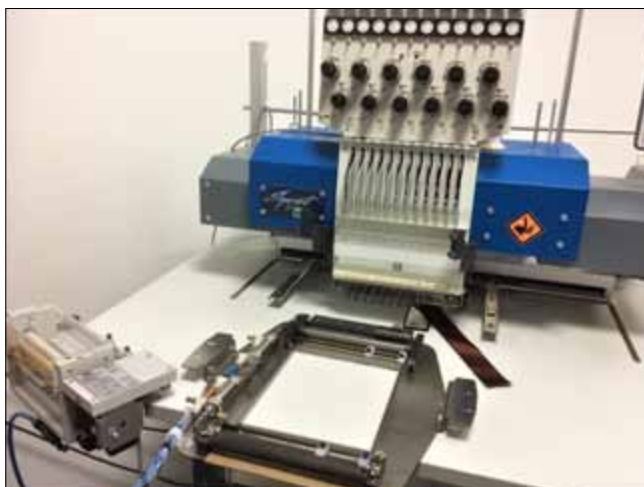

Place the coil with a new tape on the embroidery machine.



### Diagram of Laying the Tape

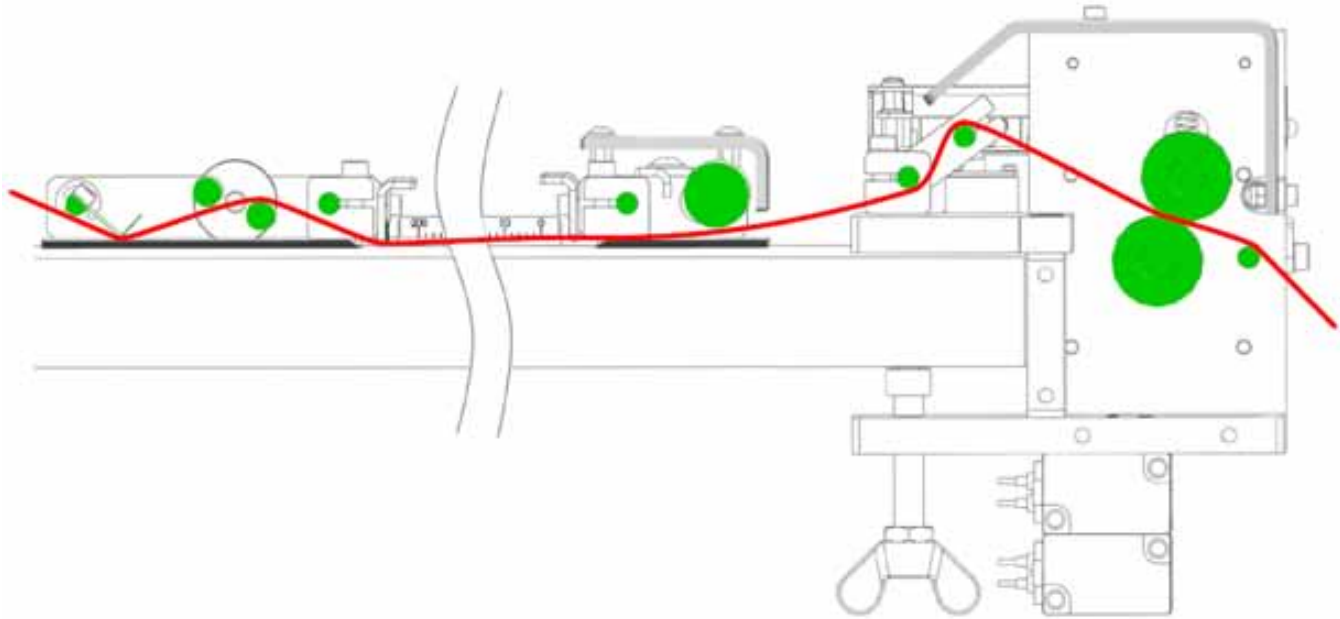

**3.**

Install only presser foot for the tape with a width of 10 to 40 mm.

The tape with a width of 10 mm is shown in the photo.



**4.**

Adjust the guides to the width of the tape.

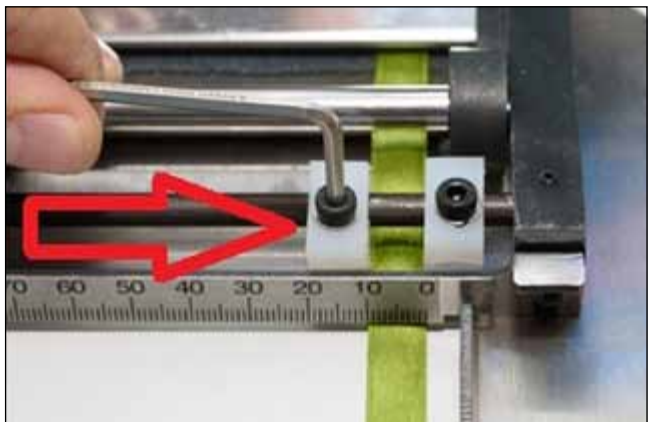

**5.**

The tape with a width of 40 mm is shown in the photo.

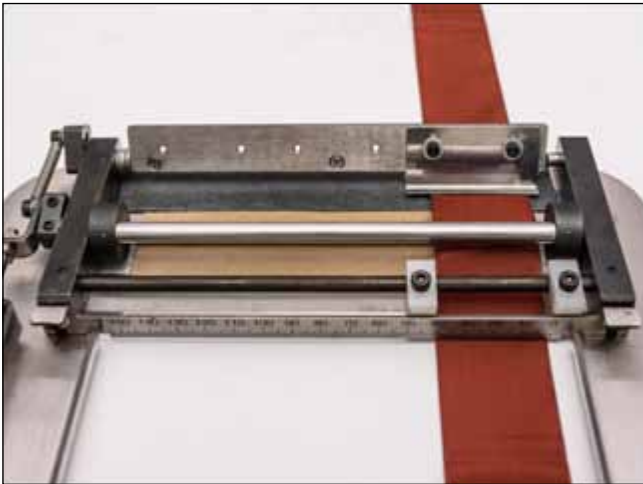

**6.**

Incorrect placement of the tape with a width of 50 mm is shown in the photo.



**7.**

Correct placement of the tape with a width of 50 mm is shown in the photo.



**8.**

Adjust the pressing angle of the presser foot in the range of 65-85°.

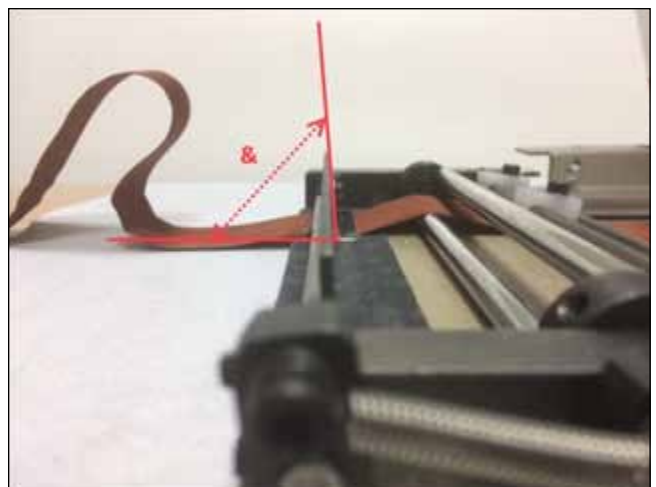

**9.**

Adjusting the spring tension set the tape pre-tensioning force in the range of 0.6 to 1.5 kg.

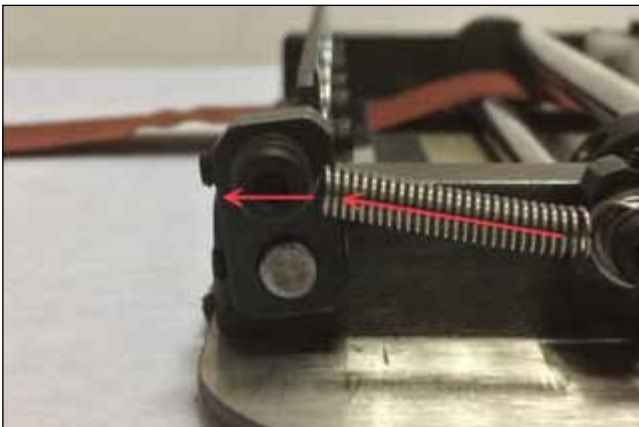
**10.**

Measurement of the tape pre-tensioning force using the electronic balance is shown in the photo.

**ATTENTION!**

The tape should be pressed only by presser foot.

**11.**

Pull out 1-2 m of the tape.

Make sure the tape:

- moves uniformly;
- does not slip from the presser foot.

**12.**

When the tape is slipping adjust the presser foot.





### 13.

Loosen fixing/adjustment screws of the presser foot.



### 14.

Press and fix the presser foot with screws on each side. Repeat the test pulling of the tape.

**ATTENTION!** Incorrect adjustment of the presser foot causes embroidery failure!

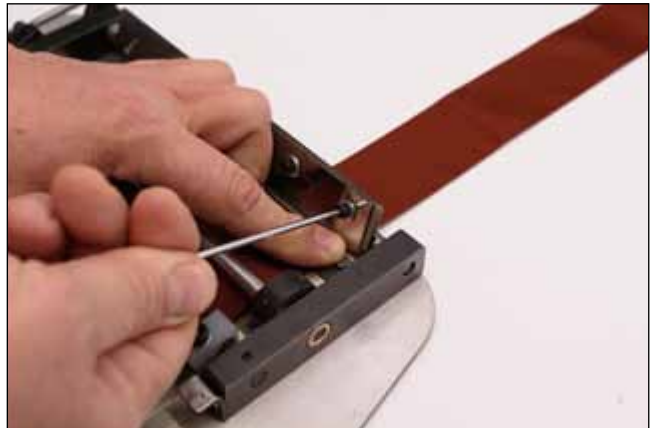

### 15.

Install the pneumatic hoop in the tubular system holder.



## 5.2 OPERATION WITH THE CONTROL PANEL.

### INITIAL SETTINGS.

#### 16.

Power on the embroidery machine.



#### 17.

Select the mode of embroidery on the tape in T8.2 menu.



#### 18.

Align the position of the hoop on the „X“ axis (to the right- to the left) so that the needle hole was centered with respect to the tape.



#### 19.

Place the tape control device (the tape coil) so the tape was going from the coil and has passed through the guide, as shown in the photo.

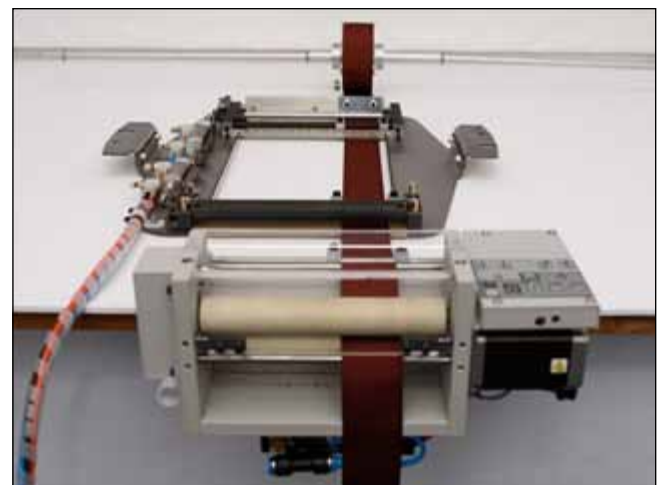

## 20.

Fix the device.



## 21.

Supply compressed air (6 bar) to the device.



## 22.

Switch on the manual mode of the ROLL2BASKET device.



## 23.

Release the tape from the front of the hoop by clicking the button, as shown in the photo.





## 24.

Release the tape behind the hoop by clicking the button, as shown in the photo.



## 25.

**For tapes up to 2 mm (or non-rigid tapes):**

Pull the tape, as shown in the photo. Place the end of the tape between the rollers.

**ATTENTION!!!**

**REMOVE FINGERS FROM THE ROLLERS. CLOSE THE PROTECTIVE ACRYLIC CASE.**



## 26.

**For tapes thicker than 2 mm (or rigid tapes):**

Pull the tape, as shown in the photo. Place the end of the tape between the rollers.

**ATTENTION!!!**

**REMOVE FINGERS FROM THE ROLLERS.**



Increase the spring tension.



## 27.

Press the button of the forward rotation of rollers.



## 28.

Pull out the tape to make the free end of 30 cm long below rollers.

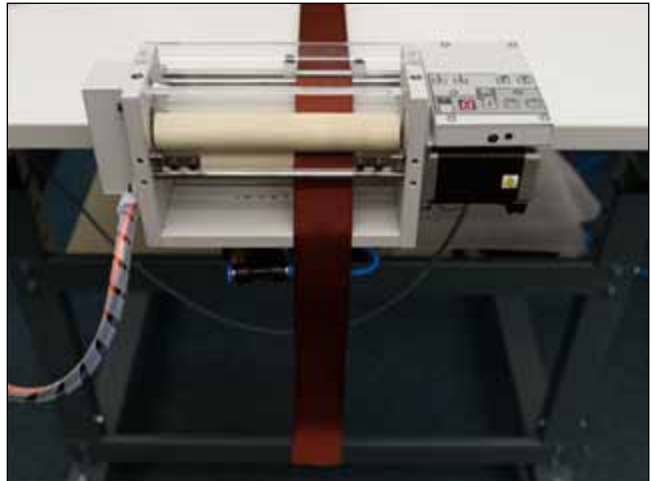

## 29.

Reset the value of compensation to zero. To do this, press and hold the button „-“ until LED flashes. Set the value 0 pressing the button.



## 30.

Press the button «FRONT».  
The tape will be pressed against the front.



**31.**

Press the button «REAR».  
The tape will be drawn and pressed by the tension mechanism of the pneumatic hoop.

**32.**

**For tapes thicker than 2 mm (or rigid tapes) as well as for tapes wider than 50 mm:**

Select the mode of „one-way feeding of the tape“ by clicking the button, as shown in the photo.

Indicator under the right arrow will light.

**33.**

**For tapes up to 2 mm (or non-rigid tapes) as well as for tapes narrower than 50 mm:**

Select the mode of „two-way feeding of the tape“ by clicking the button, as shown in the photo.

Indicator under the double-headed arrow will light.

**34.**

Press the button «Start 2».  
THE DEVICE IS READY FOR USE.



## 5.3 EMBROIDERY. EMBROIDERY FEATURES.

### 35.

Set the tape embroidery settings in T8.2 menu.



### 36.

Load the embroidery design.

**ATTENTION! Maximum embroidery length must not exceed 200 mm.**

Select the origin point and bypass the contour of the embroidery design („Design Range“ function). Start embroidering.



### 37.

If embroidery design on the tape is continuous pattern which consists of a plurality of identical elements repeated, check alignment the end of the 1st element and the beginning of the 2nd element after the 2nd element embroidery started.



### 38.

If the gap (X mm) is formed between repeating design features, it should be eliminated by the positiv compensation.

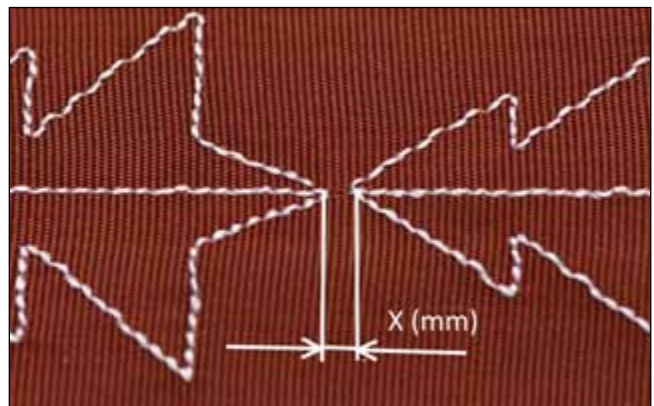

### 39.

For example,  $X = 1.0$  mm.  
Compensation step is 0.2 mm. Make 5 steps to compensate the gap 1.0 mm.

For this press and hold the button «+» until LED starts blinking. Set the value 5 by pressing the button.

Continue embroidering. Check the gap in the next step. If necessary, repeat setting of compensation.

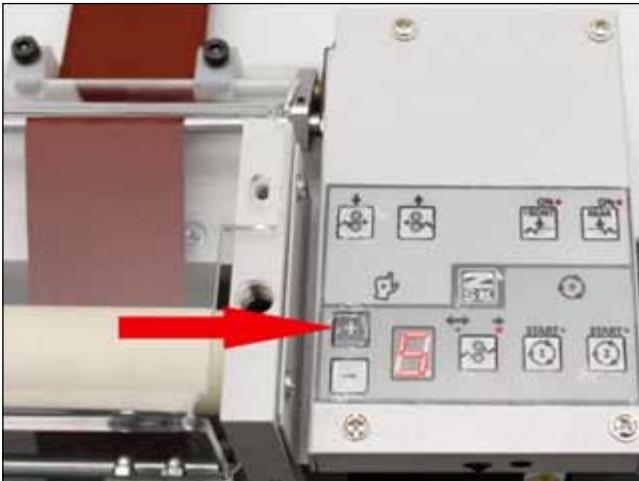

### 40.

If the 2nd element overlaps on the 1st one it means the following:

- the tape in the longitudinal direction may be stretched strongly and is not suitable for continuous design (replacement of the tape recommended);
- the tape pre-tensioning force more than 1.5 kg, resulting in the disruption of the tension mechanism (adjustment of the pre-tensioning force is recommended).

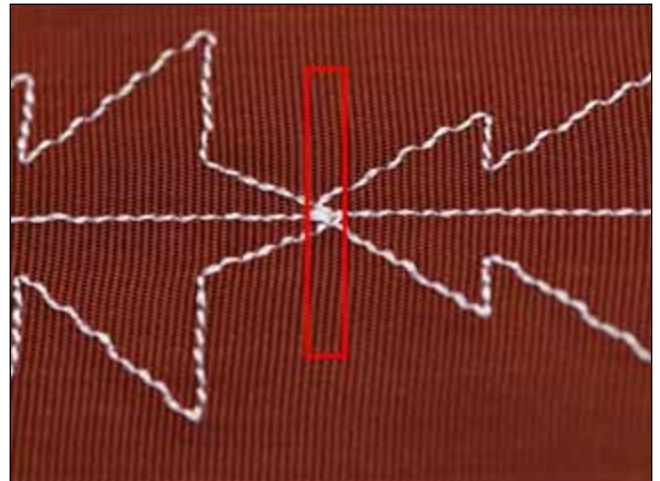



## 5.4 TIPS FOR CREATING EMBROIDERY DESIGNS

### 41.

Preferably, align the center lines of embroidery patterns and the tape. Embroidery direction on the picture- along the Y-axis (along the tape), from bottom to top.

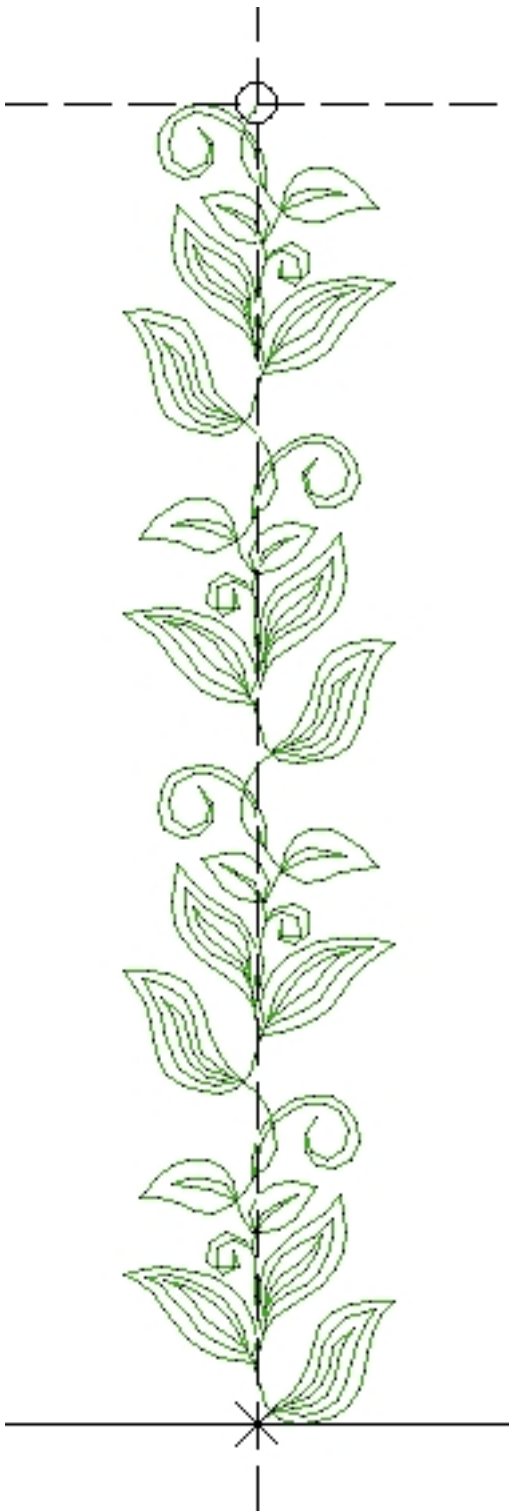

### 42.

Set stitch density greater than 0.7 mm for the tape with thickness from 0.2 to 0.35 mm, preferred stitch direction- as close as possible to the direction along the tape.



**43.**

When the embroidery design is loaded, IT HAS NOT BEEN MODIFIED OR OPTIMIZED!

(The sequence of embroidery may be broken).

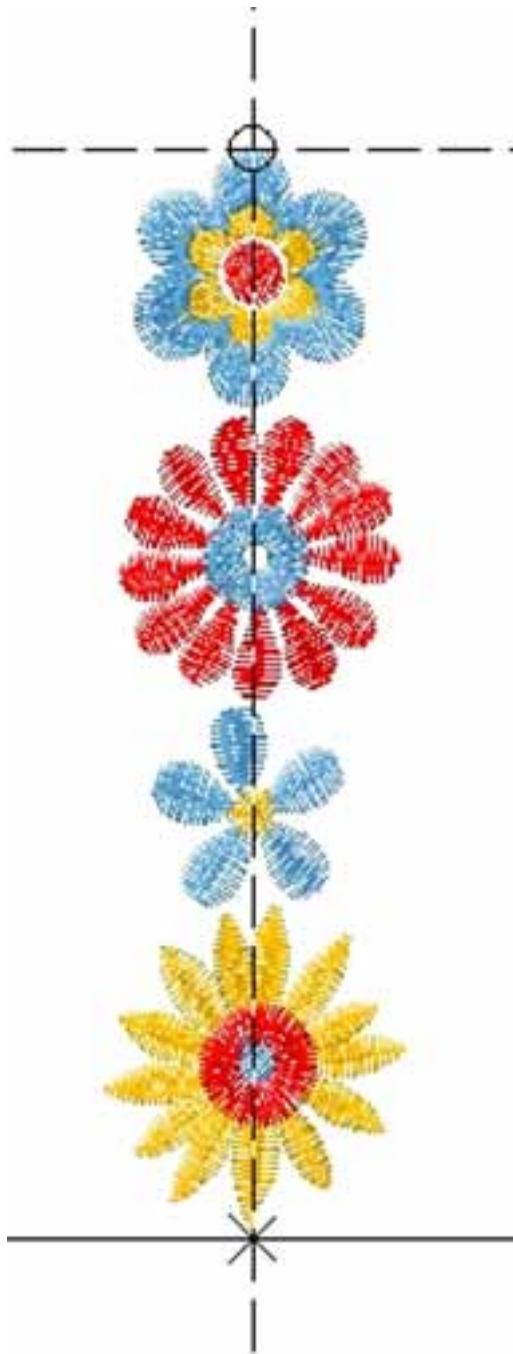
**44.**

Embroidery on the tape with thickness 1 mm and width 60 mm is shown in the photo.



# 6.1 ELECTRICAL INSTALLATION (WITH KSP-10 BOARD COMMUTATION)

**1.**  
Power off the embroidery machine.



**2.**  
Reference:  
2.1. Fixing screws 3,5\*10;  
2.2. KSP-10 adaptor board, Ver.3 23-02-2016  
2.3, 2.4. Flat cable connectors.  
2.5. Power connector.  
2.6. Jump stitch electromagnet connector.  
2.7. Connector X9.  
Place the coil with a new tape on the embroidery machine.

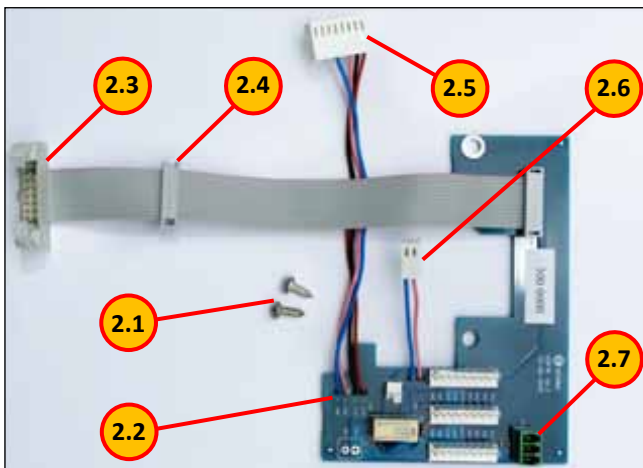

**3.**  
Reference:  
3.1. Tape control device.  
3.2. Cable № 11203002  
3.3. Cable 3.2 connectors.  
3.4. Control system.

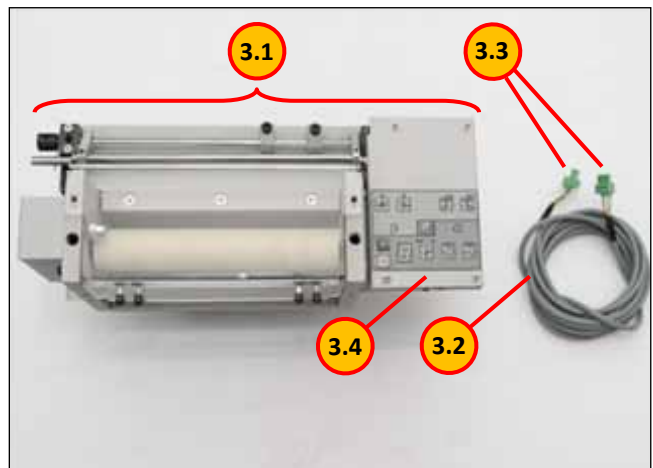



### 4 a.

Remove the cover from the head.  
To do this, press the cover in the direction of the arrows.



### 4 b.

Pull the cover toward yourself.



### 5 a.

Reference:

5.1, 5.2. Fastening screws of the ZSK KSP-10 board.  
5.3. Connector.

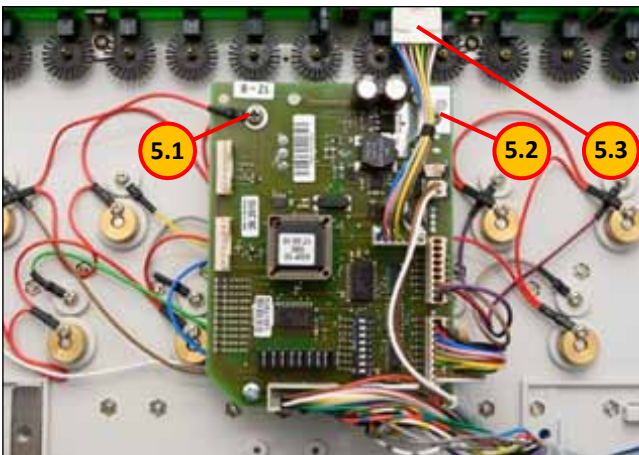

### 5 b.

Unscrew the fastening screws 5.1, 5.2.

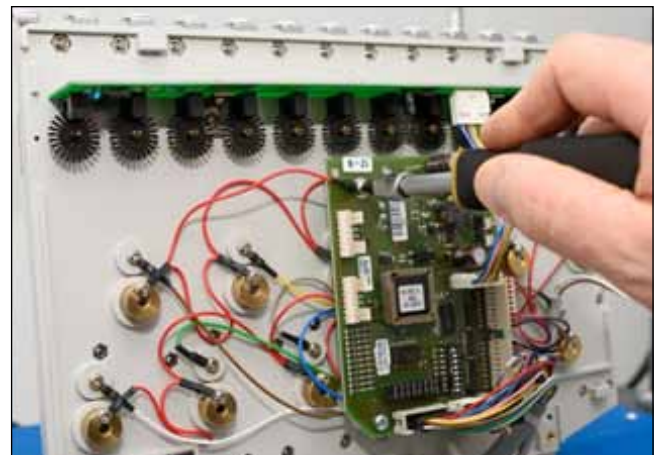

### 5 c.

Disconnect connector 5.3.

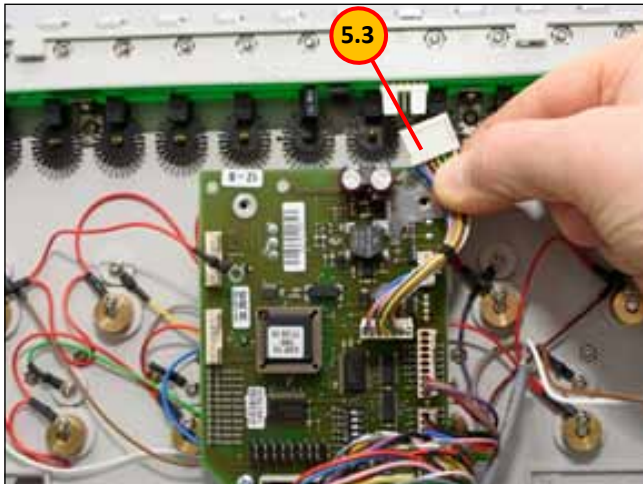

### 6 a.

Place the KSP-10 adaptor board (Ver.3 23-02-2016) as shown in the photo.

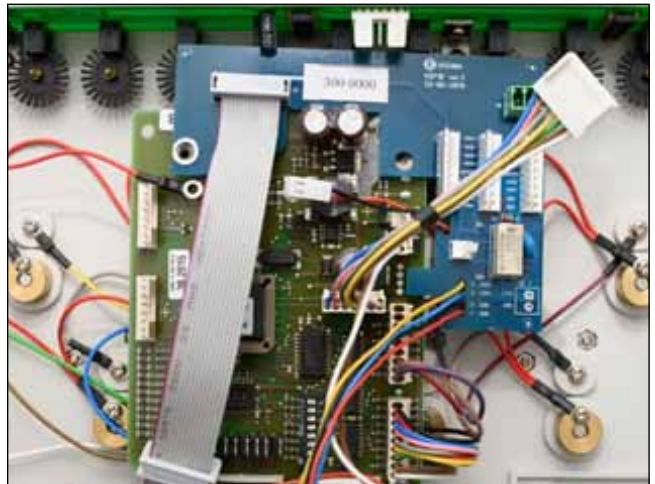

### 6 b.

Place the terminal 6.1 between the boards.

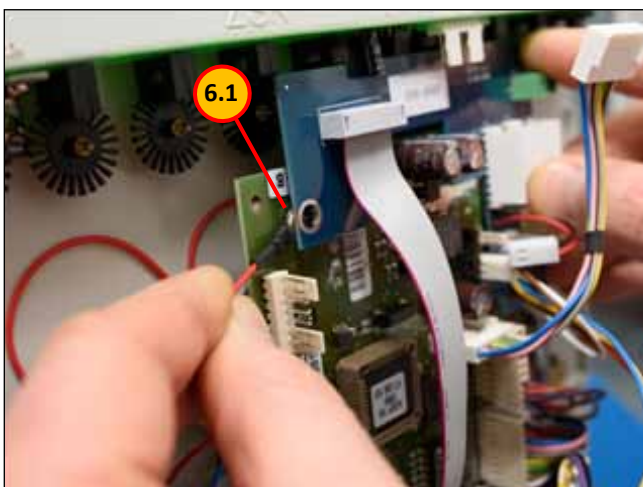

### 7.

Using two screws 2.1 supplied fix the adaptor as shown in the photo.





**8.**

Connect the connector 5.3 as shown in the photo.



**9 a.**

Connect connectors 2.3, 2.4 of the adapter flat cable to the KSP BUS as shown in the photo.

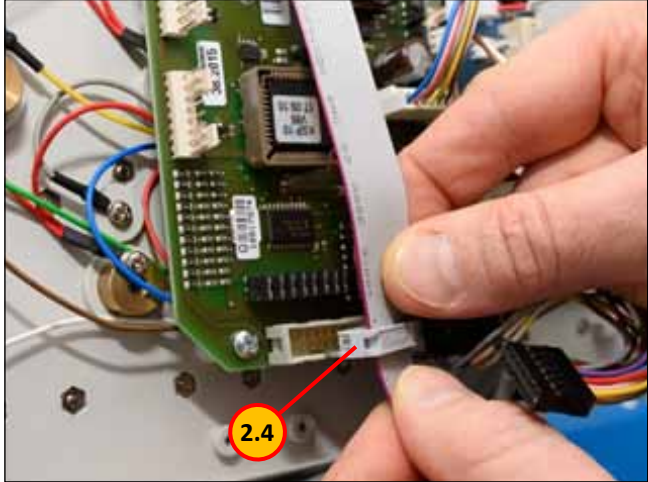

**9 b.**

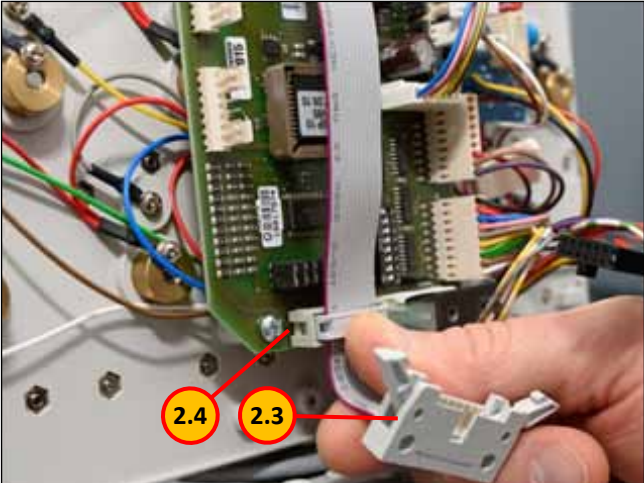

**9 c.**

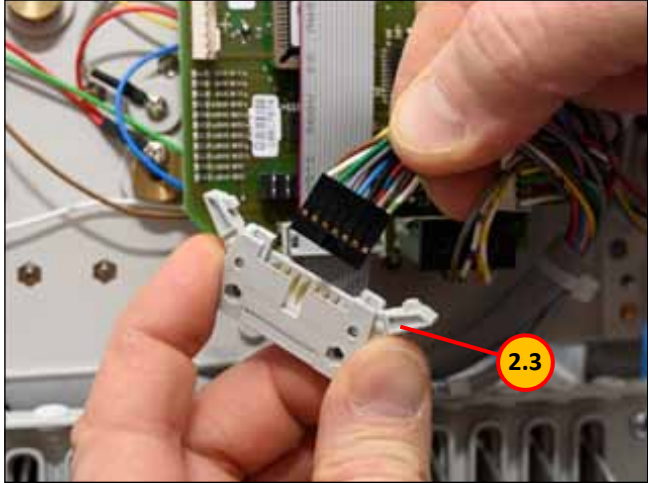

9 d.

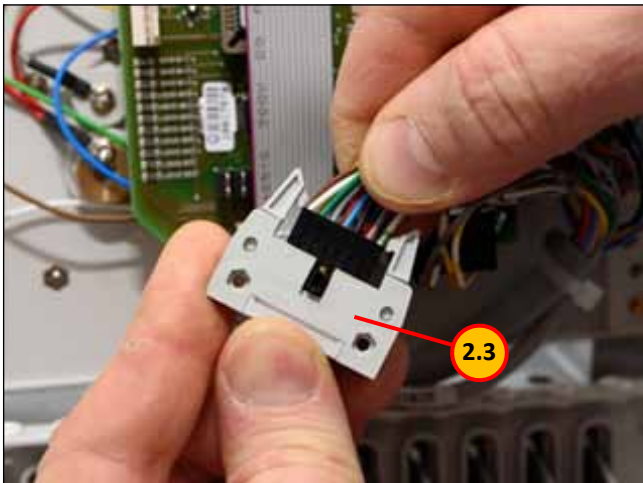

9 e.

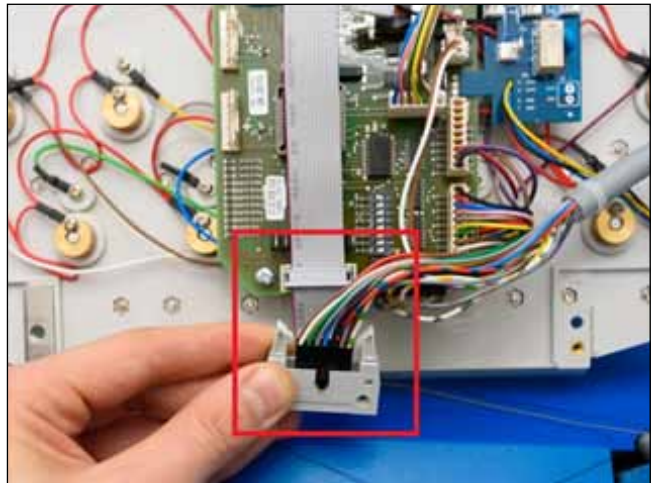

10 a.

Connect the power connector 2.5 of the KSP10 adapter as shown in the photo.

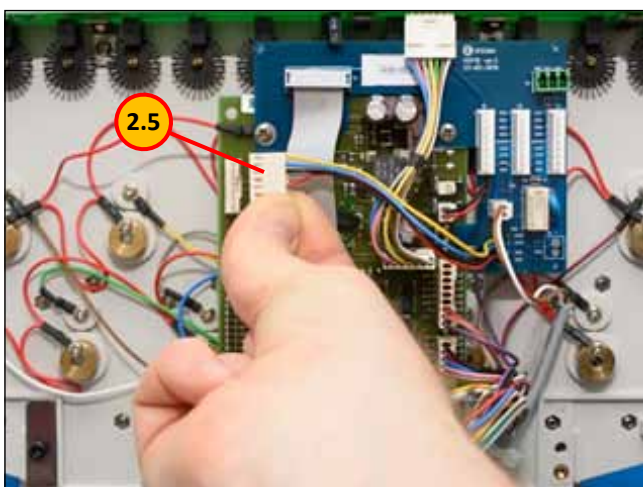

10 b.

Using two screws 2.1 supplied fix the adaptor as shown in the photo.

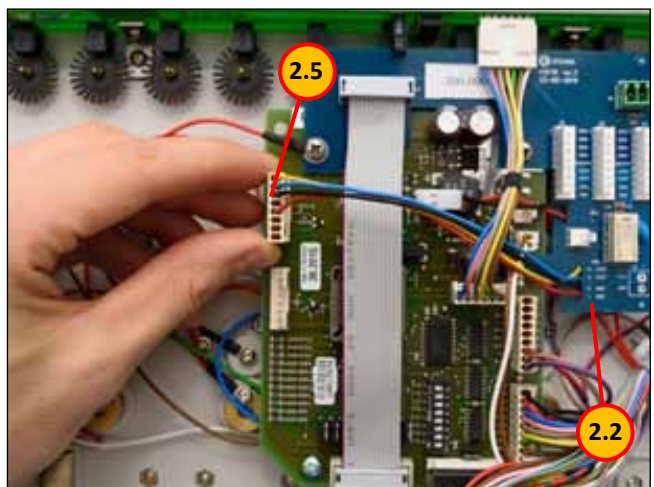



**11 a.**

Reconnect the jump stitch electromagnet connector 11.1 to the KSP10 adapter board as shown in the photo.

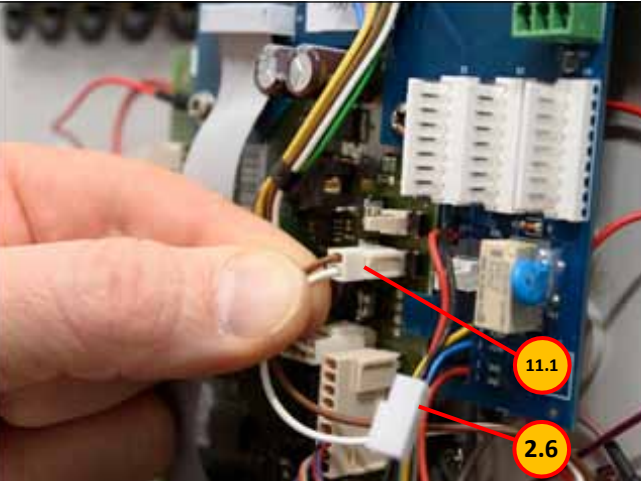

**11 b.**

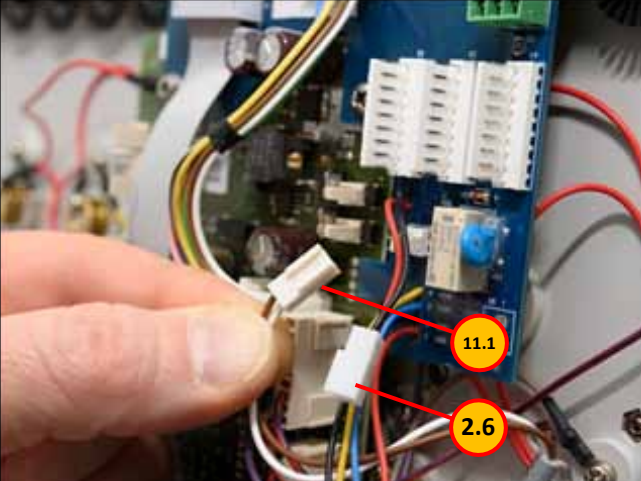

**11 c.**

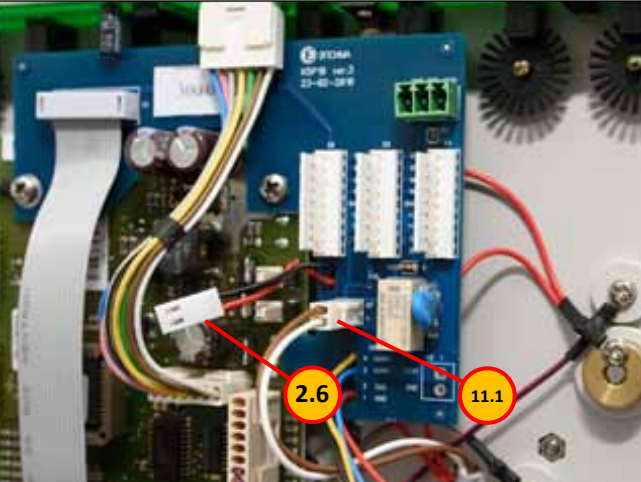

**11 d.**

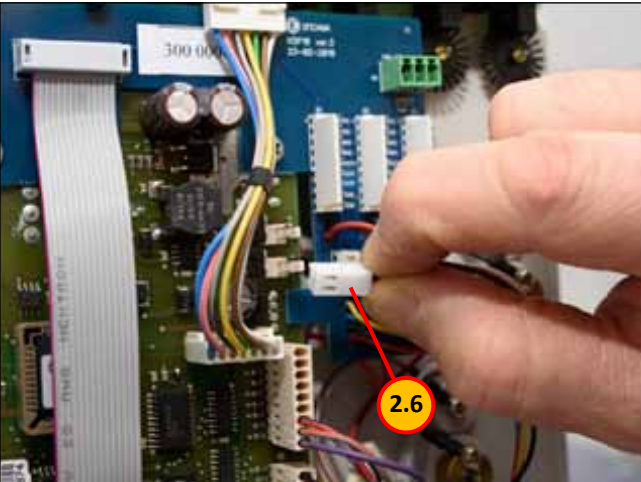

### 11 e.

Installation of the KSP10 adapter (Ver.3 23-02-2016) is finished.

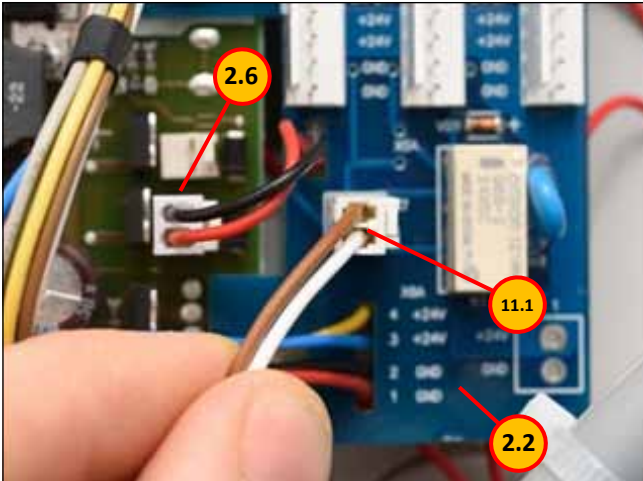

### 12 a.

Connect the connector 3.3 of the cable supplied to the control system 3.4 as shown in the photo.

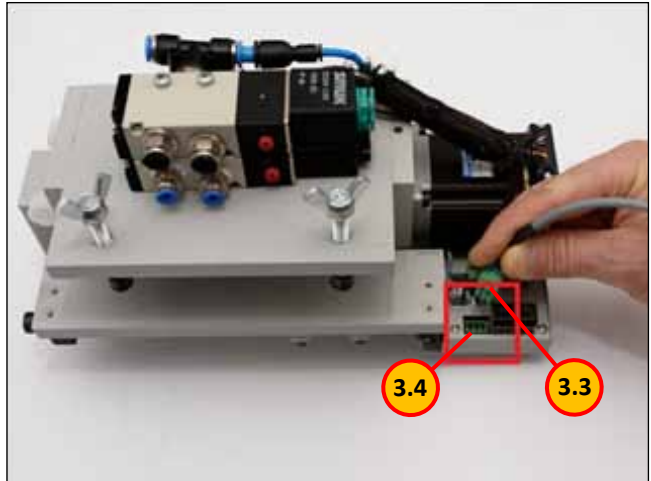

### 12 b.

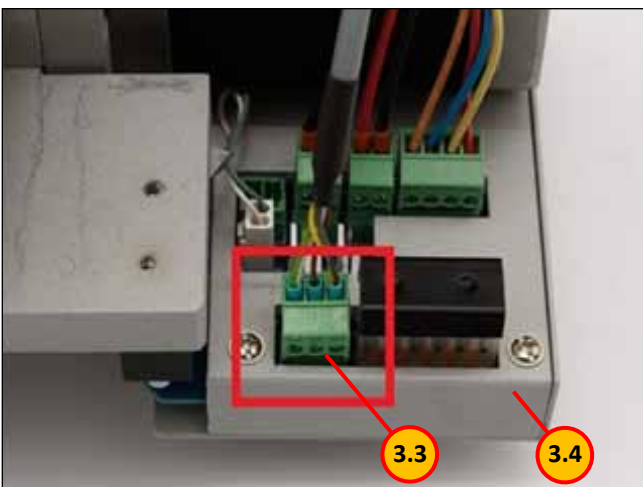

### 13 a.

Connect the connector 3.3 of the cable 3.4 supplied to the connector 2.7 (X9) of the KSP-10 adaptor (Ver.3 23-02-2016).

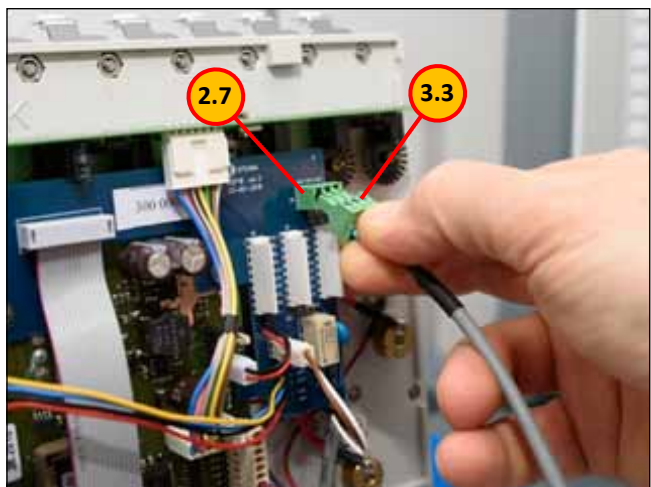

### 13 b.

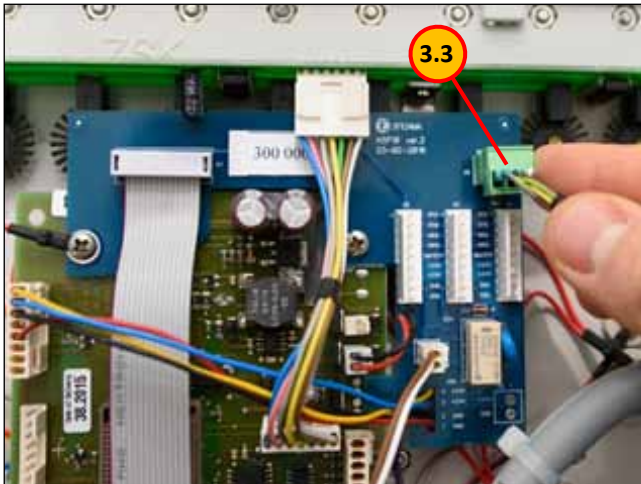

### 14 a.

Tighten the cable 3.4 with a cable binder.



### 14 b.

Cut off the excess length of the binder.



### 14 c.

Close up the board of the head with the cover.





## 15.

Place the tape control device on the embroidery machine table.

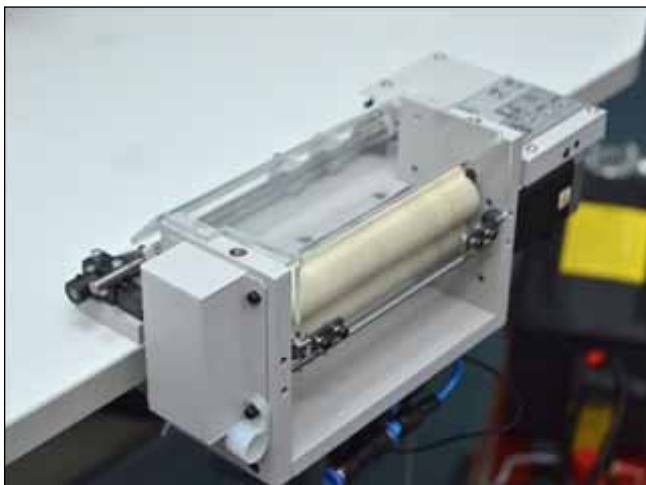

## 16.

Fix the device to the embroidery machine tabletop with the clamp.





## 6.2 ELECTRICAL INSTALLATION

(MINI BUS CONTROLLER (MCP31))

1. Power off the embroidery machine.



2. Disconnect the power cable.



3. Unscrew the back cover mounting screws.



4. Remove the back cover.



## 5.

Reference:

- 5.1. KSP BUS CONTROLLER MINI № 1020000.
- 5.2. Cable № 1023000.
- 5.3. Cable № 1023004.
- 5.4. Cable № 1023005.

Connect the cable 5.2 supplied to the board KSP BUS CONTROLLER MINI 5.1 as shown in the photo.

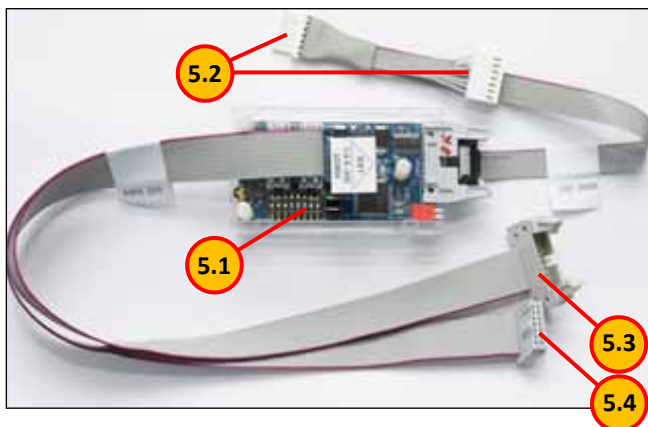

## 6.

Open the cover of the embroidery machine, detect the board MCP31; detect connectors X3 “ENCODER” (6.1) and X6 “KSP BUS” (6.2).

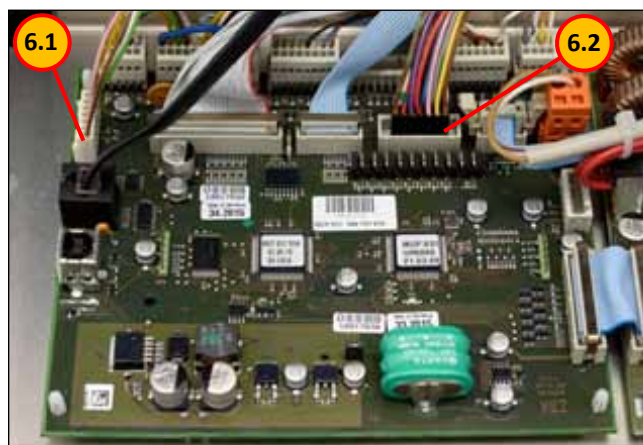

## 7.

Disconnect the detachable connection 6.2 (X6 “KSP BUS”) as shown in the photo.

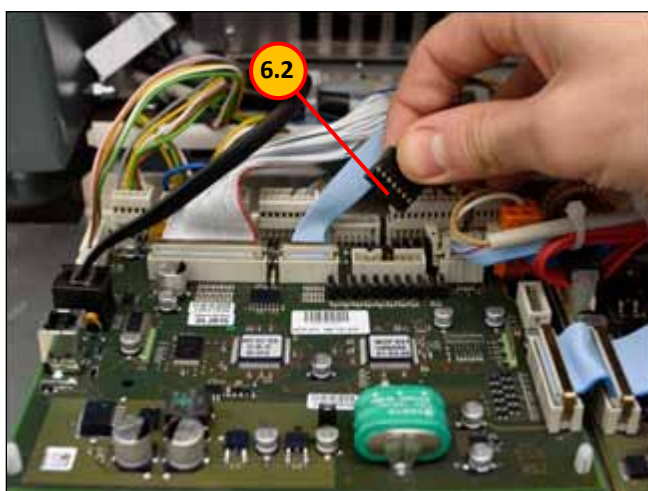

## 8.

Disconnect the detachable connection 6.1 (X3 “ENCODER”) as shown in the photo.

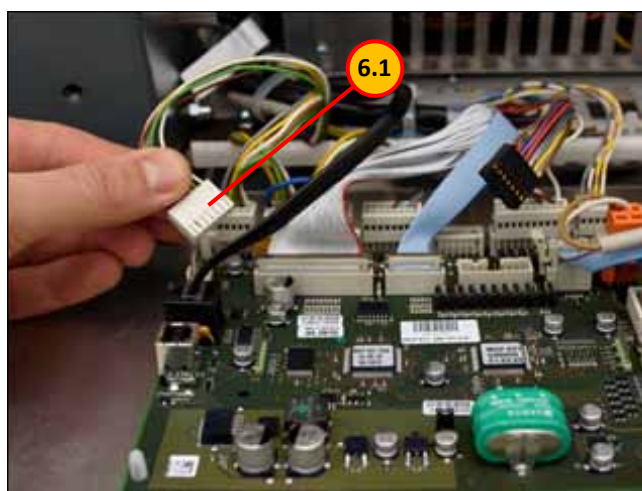

**9.**

Connect the cable 5.4 plug to the socket X6 of the board MCP31.

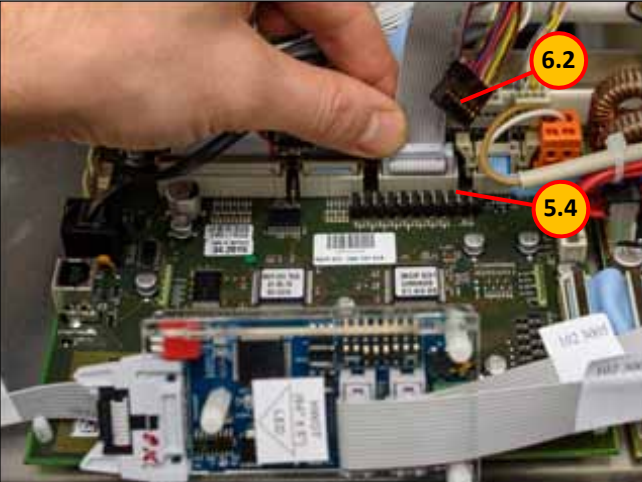

**10.**

Connect the cable 5.3 plug to the socket of BUS KSP as shown in the photo.

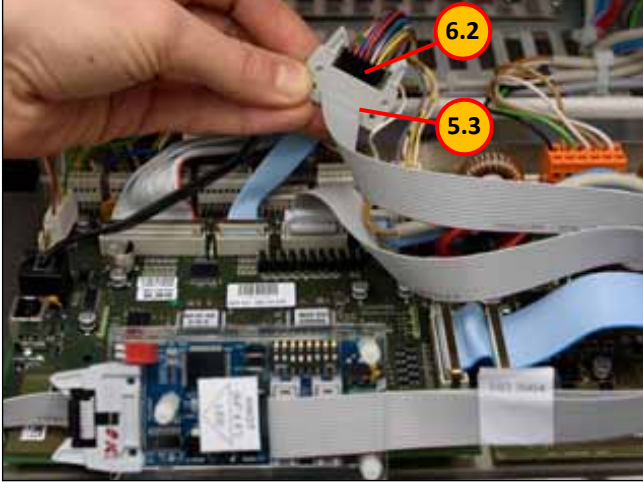

**11.**

Connect the cable "ENCODER" plug to the cable 5.2 socket as shown in the photo.

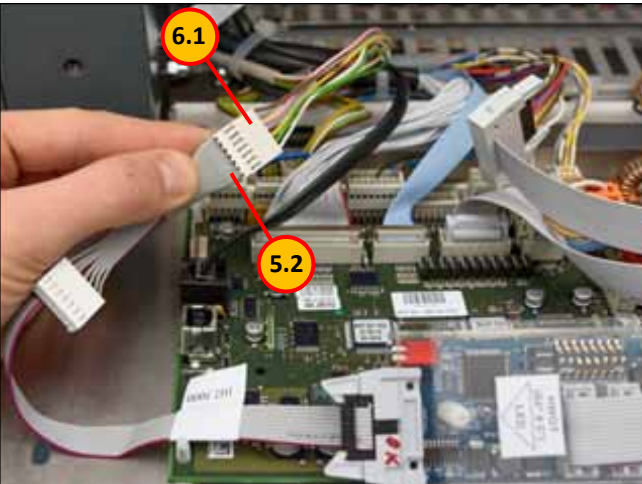

**12.**

Connect the cable 5.2 plug to the connector X3 of the board MCP31 as shown in the photo.

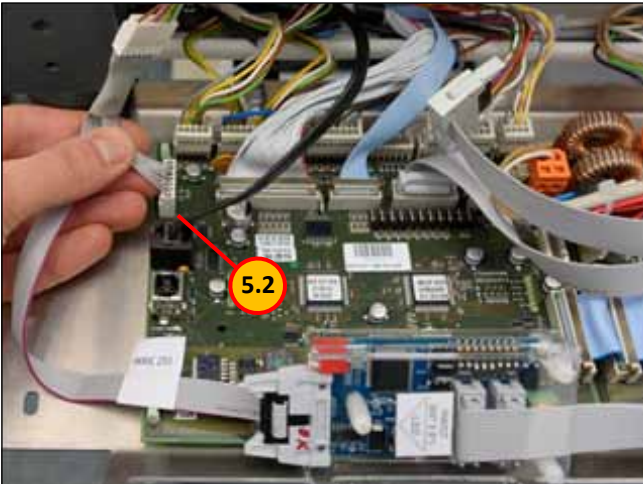



### 13.

Check DIP switches S9, S10.  
For embroidery machines series «SPRINT» DIP settings are shown in the photo.

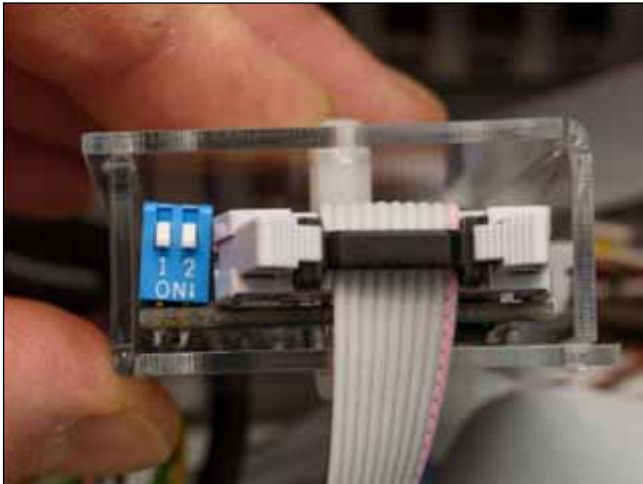

### 14.

Place BUS CONTROLLER mounted next to the power supply, as shown in the photo.



### 15.

Gently close the back cover. Avoid falling the wires in the slot when the cover is closed.



### 16.

Installation is finished.

#### Information for technicians

When properly connected, green LED „HWOT“ of the board KSP BUS CONTROLLER MINI should light up when the embroidery machine main shaft is set in the position 58°-68° as shown in the photo.

If LED „HWOT“ **does not light up, check the DIP switches configuration** (see Annex 7.1 DIP SWITCH SETTINGS )



## 6.3 PNEUMATIC INSTALLATION

### 1.

Power off the embroidery machine.



### 2.

Reference:

1. Pneumatic embroidery hoop № 1110 0000;
2. Pipe 8mm, length 1,5 m № 11302139;
3. Pressure reducer № 1130 0000

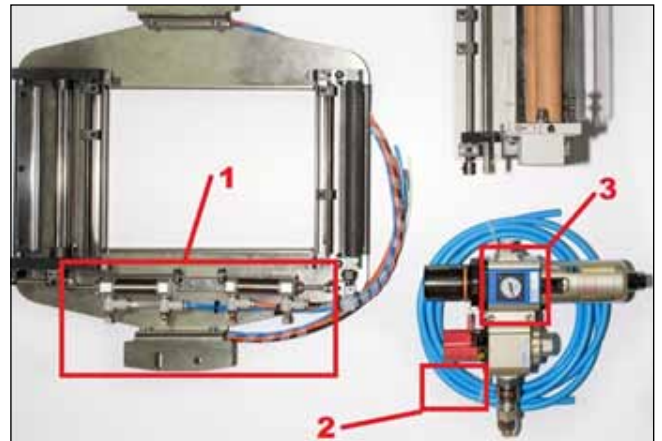

### 3.

Connect the pressure reducer № 1130 0000 to the air line or a separate compressor as shown in the photo.



### 4.

Connect the pipe №11302139 to the pressure reducer output as shown in the photo.



### 5.

Connect the other end of the pipe № 11302139 to the valves of the tape control device as shown in the photo.



### 6.

Lay four colored tubes connected to the pneumatic embroidery hoop through the plastic lugs on the tape control device housing as shown in the photo.

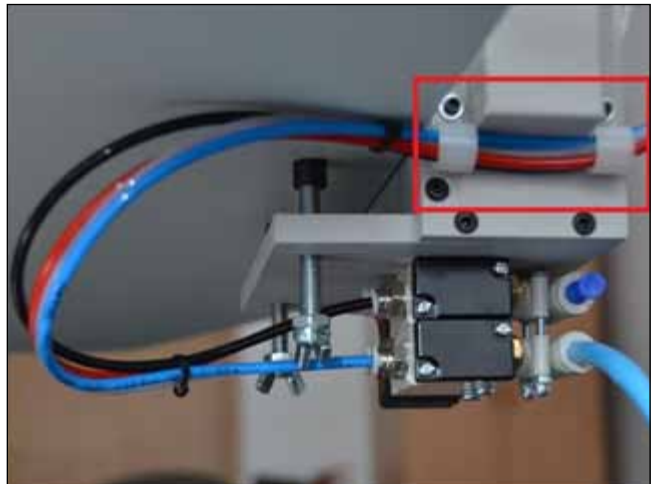

### 7.

Connect colored tubes as shown in the photo.

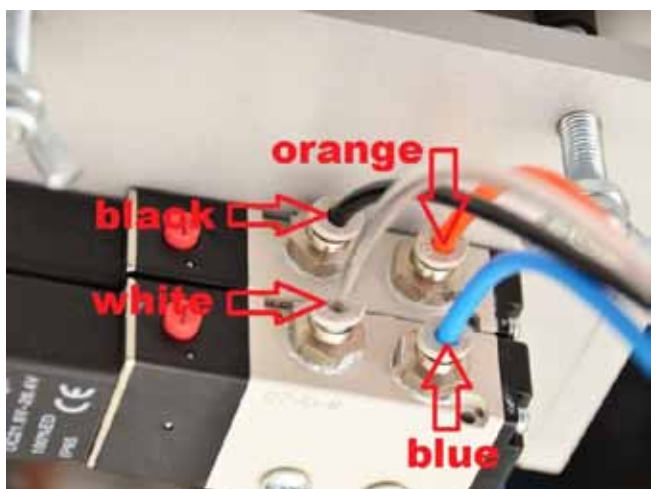
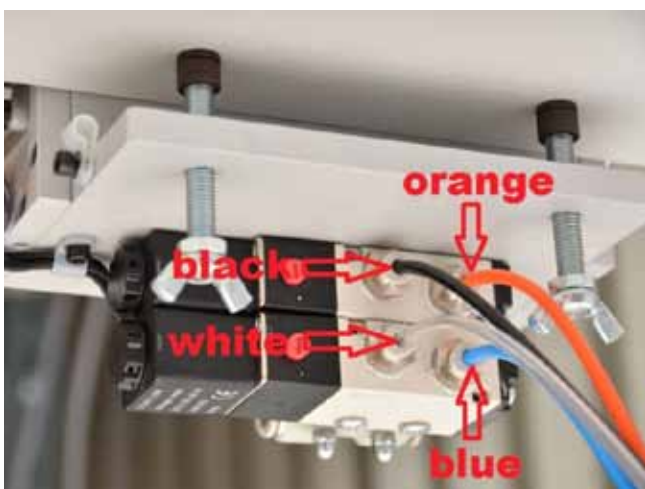

8.

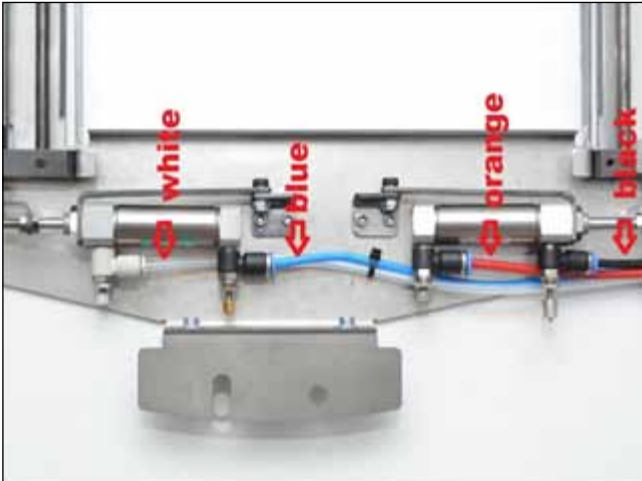

9.

Open air tap by gently pressing and turning the knob as shown in the photo.



10.

By rotating the pressure control knob of the pressure reducer, set the output pressure 6 bar.



For normal operation of the pressure reducer the input pressure must be greater 6 bar!

Pneumatic installation is finished!





## 6.4 Tape Holder Assembly

### 1.

Reference:

1. Holder (left, right).
2. Guide rail axis.
3. Coil axis.
4. Fixing ring.
5. Coil cheek (left, right).

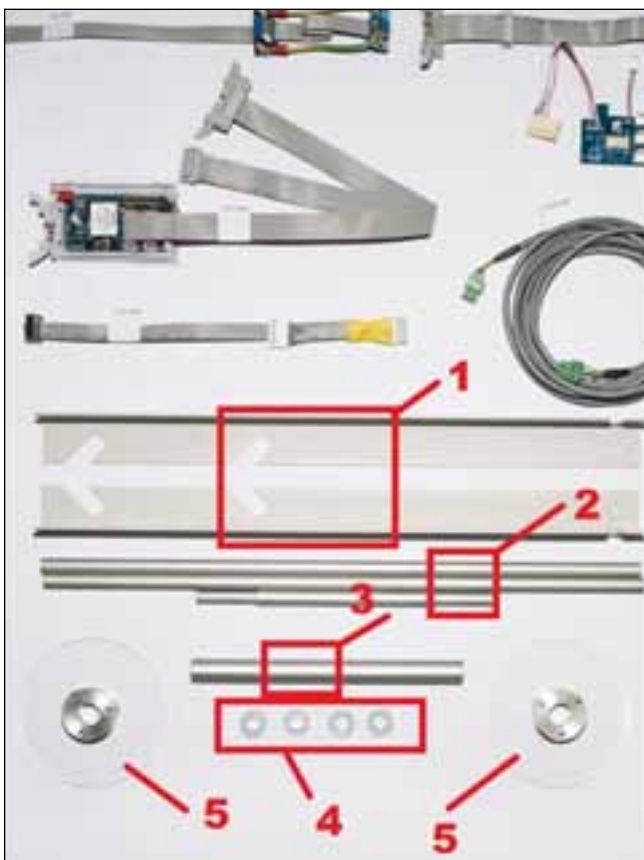

### 2.

Unscrew two screws securing the side cover of the embroidery machine. Fix the holder supplied with these screws as shown in the photo. Repeat the operation for the right cover machine.





### 3.

Assemble parts of the guide rail axis supplied. For the rigidity, pipe joints should be laid with the pieces of nonwoven fabric.



### 4.

Fix the right (left) coil cheek on the edge of the coil axis. Gently tighten the screw.



**5.**

Put the coil with a tape on the coil axis.



**6.**

Put the second coil cheek on the opposite side of the coil axis. Holding the tape between the coil cheek, lock it against displacement with the fixing ring as shown in the photo.



**7.**

Put all the assembly with the tape on the guide rail axis previously gathered. Select the position of the coil with a tape in front of the hoop so that it does not displace while a tape is pulled.



**8.**

Secure the guide rail axis assembled on both the right and left holder with the fixing ring as shown in the photo.





## 6.5 CALIBRATION - PROXIMITY HALL EFFECT SENSOR

### THE PROXIMITY HALL EFFECT SENSOR OF THE TENSION LEVER

1.

Power on the embroidery machine.



2.

Select the manual mode by pressing the „ZSK“ button. The indicator highlighted in the photo will light up.

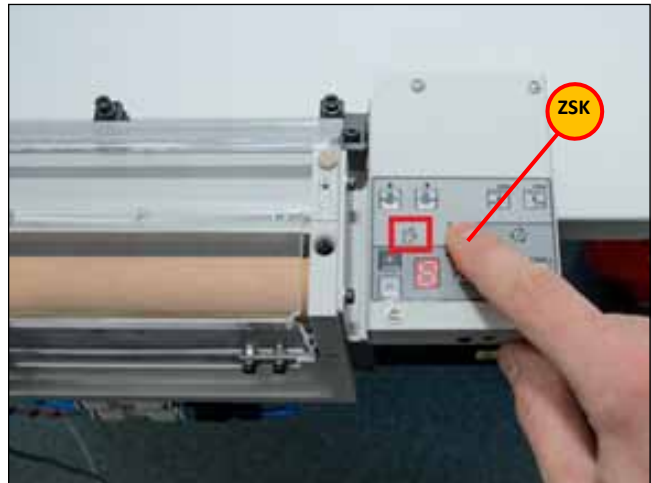

3.

Simultaneously press buttons „+“ and „-“. Hold them at least 4 sec until the 7-segment display will start to flash slowly (approx. 3 times per second).

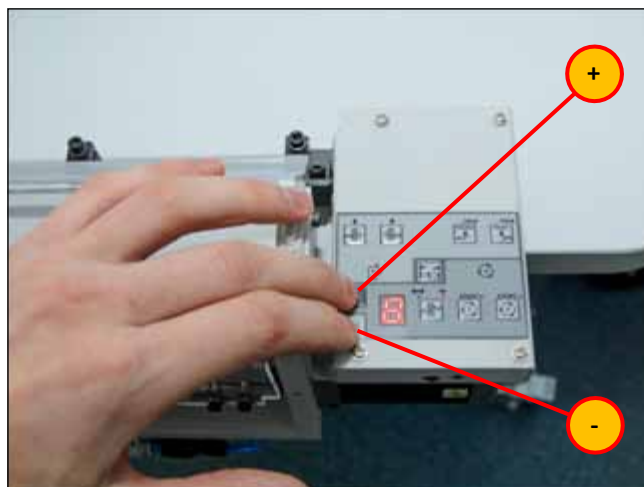

4.

In the free state, the tension lever is urged by a spring to its highest position. Thus the permanent magnet on the end of the tension lever is disposed as close as possible to the Hall sensor on the control board.

The 7-segment display readings should be 0. If the readings are different from 0, an additional adjustment of the magnet position relative to the Hall sensor is required.



**5.**

Press the tensioning lever to move it down to its lowest position. Thus the permanent magnet on the end of the tensioning lever is disposed as far as possible from the Hall sensor control board. The 7-segment display readings will be in the range of 7-9.

**6.**

Release the tension lever to return it to its highest position. Simultaneously press buttons „-“, „1“, „2“, as shown in the photo. Hold them for at least 0.5 sec.

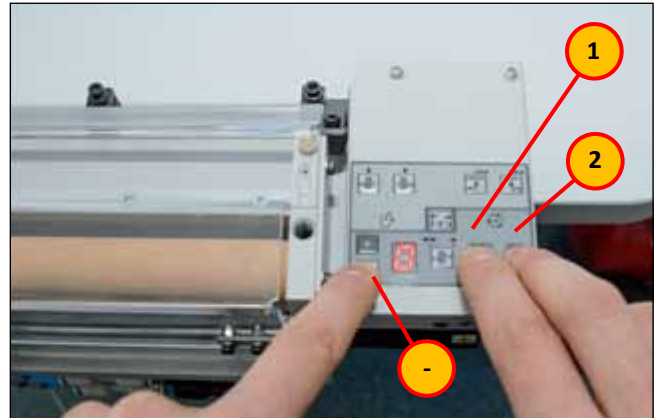
**7.**

Push with a force on the tensioning lever to move it down to its lowest position. Hold the tensioning lever while pressing buttons „+“, „1“, „2“, as shown in the photo. Hold the lever and buttons for at least 3 seconds to turn off briefly the 7-segment display.

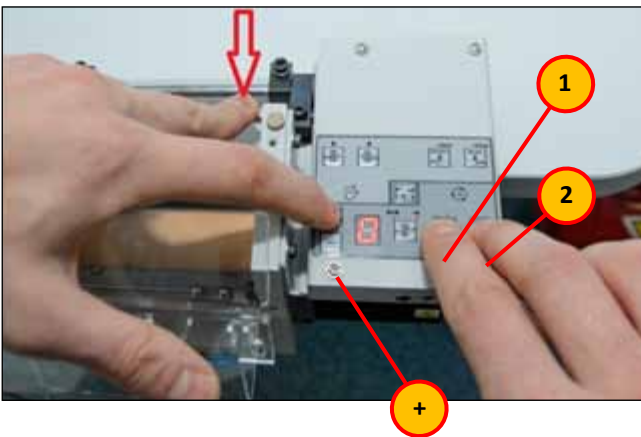
**8.**

After an automatic calibration the device returns to normal automatic operation mode.



## 6.6 TESTING THE FORCE SENSOR OF THE TENSIONING MECHANISM (THE LOWER SENSOR)

1.

Power on the embroidery machine.



2.

Select the manual mode by pressing the „ZSK“ button. The indicator highlighted in the photo will light up.

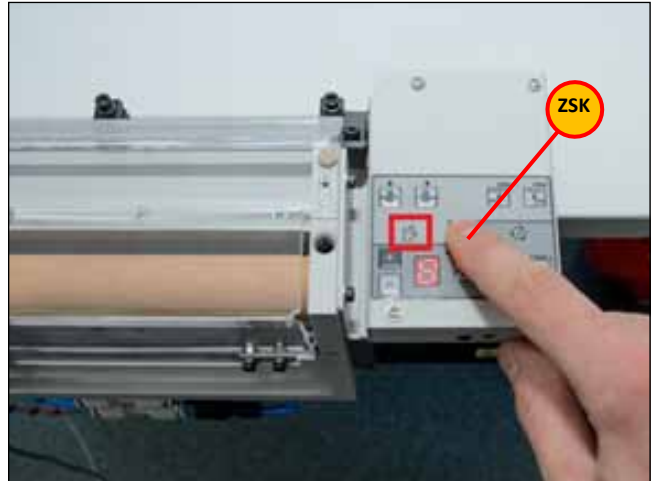

3.

Simultaneously press buttons „+“ and „-“. Hold them at least 6 sec until the 7-segment display will start to flash very frequently (approx. 7 times per second).

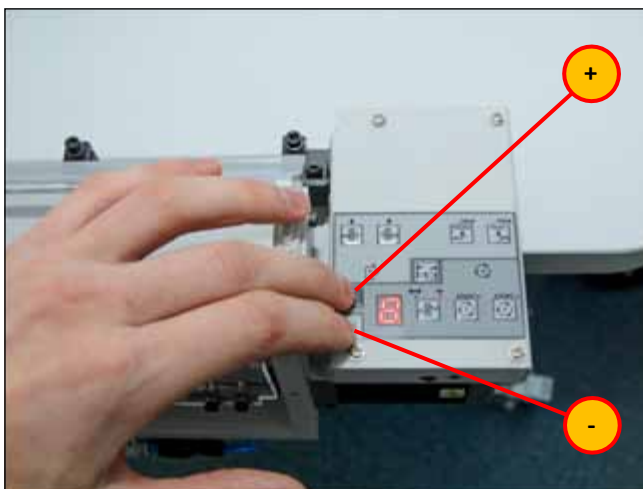

4.

When the tension lever is released the 7-segment display readings should be 8-9.





## 5.

Apply force to the tension lever to move it down against the stop. By further pressing on the tension lever the 7-segment display readings will change (decrease). When a force applied downwards to the tension lever is equal to approx. 1 kg the 7-segment display readings will be 4-3. This means that the force sensor is OK.



## 6.

To exit testing the force sensor simultaneously press buttons „+“ and „-“ again.

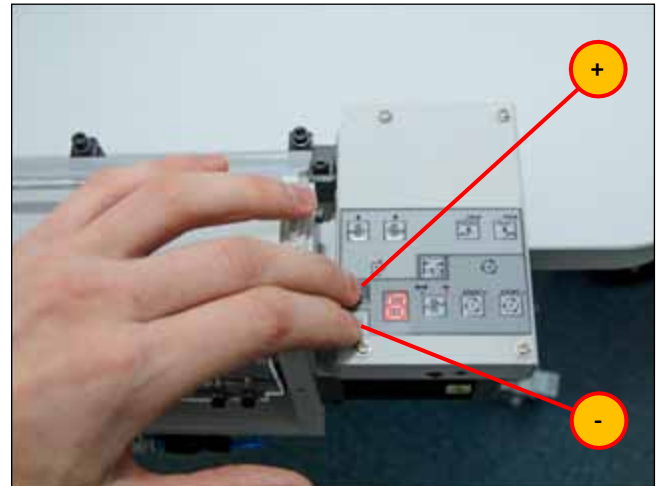

## 7.

The ROLL2BASKET device returns to normal manual operation mode.



## 7.1 DIP SWITCH SETTINGS

KSP BUS CONTROLLER (N°102 0000) for software realization 161109

DIP	Description	Default settings
S1	Needle count	OFF
S2	Needle count	OFF
S3	Needle count	OFF
S4	Left thermo cutter	ON
S5	Right cording device	ON
S6	Cording device trimming mode	ON
S7	Test pneumo controller	OFF
S8	Test cording device (use with S5)	OFF
S7+S8	Test thermo cutter	-
S9	Direction of main shaft Rotation	ON – SPRINT, J – SERIES;
OFF – OTHER.		
S10	RESERV	-
S 56	Activate Belt Device = existing	
S 73	Belt Device version b „Vertical Passage V3 X Axis“	

S1	S2	S3	Needle Count
OFF	OFF	OFF	12
OFF	OFF	ON	5
OFF	ON	OFF	6
OFF	ON	ON	7
ON	OFF	OFF	9
ON	OFF	ON	11
ON	ON	OFF	12
ON	ON	ON	15

## 7.2 ROLL2BASKET ERROR MESSAGES

The error message is displayed on the 7-segment display so that the symbol «E» and error code are shown alternately.

Error reset is performed by briefly pressing the button «ZSK». If an error reset is not possible, power off and power on again the embroidery machine.

Error code table, descriptions and troubleshooting:

Error Code	Description	Troubleshooting
E1	Stepper motor driver overload.	Check the connection of the stepper motor. Internal failure of the electronic circuit is possible. Contact the Service Center.
E2	Tensioning the tape is not possible. The end of the tape.	Check the correctness of laying the tape. Check good condition of the force sensor. Check whether there is no slippage of pulling rollers. Check air pressure. Check whether the tape is clamped with the front clamp.
E3	No signal from the Hall sensor of the tension lever when releasing the tape. It is not possible to move the tensioning lever in the middle position.	Check the operation of the tensioning lever: check there are no jamming, check good condition of the return spring. Check the range of the Hall sensor signal. Check whether there is no displacement of the tensioning lever magnet relative to the Hall sensor.
E4	No signal from the Hall sensor of the tension lever when tensioning the tape. It is not possible to move the tensioning lever in the middle position.	Check the correctness of laying the tape. Check the operation of the tensioning lever: check there are no jamming. Check the range of the Hall sensor signal. Check whether there is no displacement of the tensioning lever magnet relative to the Hall sensor.
E8	The Hall sensor calibration values stored in the EEPROM are below acceptable range.	Check the range of the Hall sensor signal. Check whether there is no displacement of the tensioning lever magnet relative to the Hall sensor. Recalibrate the magnet.
E9	The Hall sensor calibration values stored in the EEPROM are above acceptable range.	Check the range of the Hall sensor signal. Check whether there is no displacement of the tensioning lever magnet relative to the Hall sensor. Recalibrate the magnet.

# 7.3 Wiring diagram belt tape device "ROLL2BASKET" for embroidery machine ZSK (MCP31)

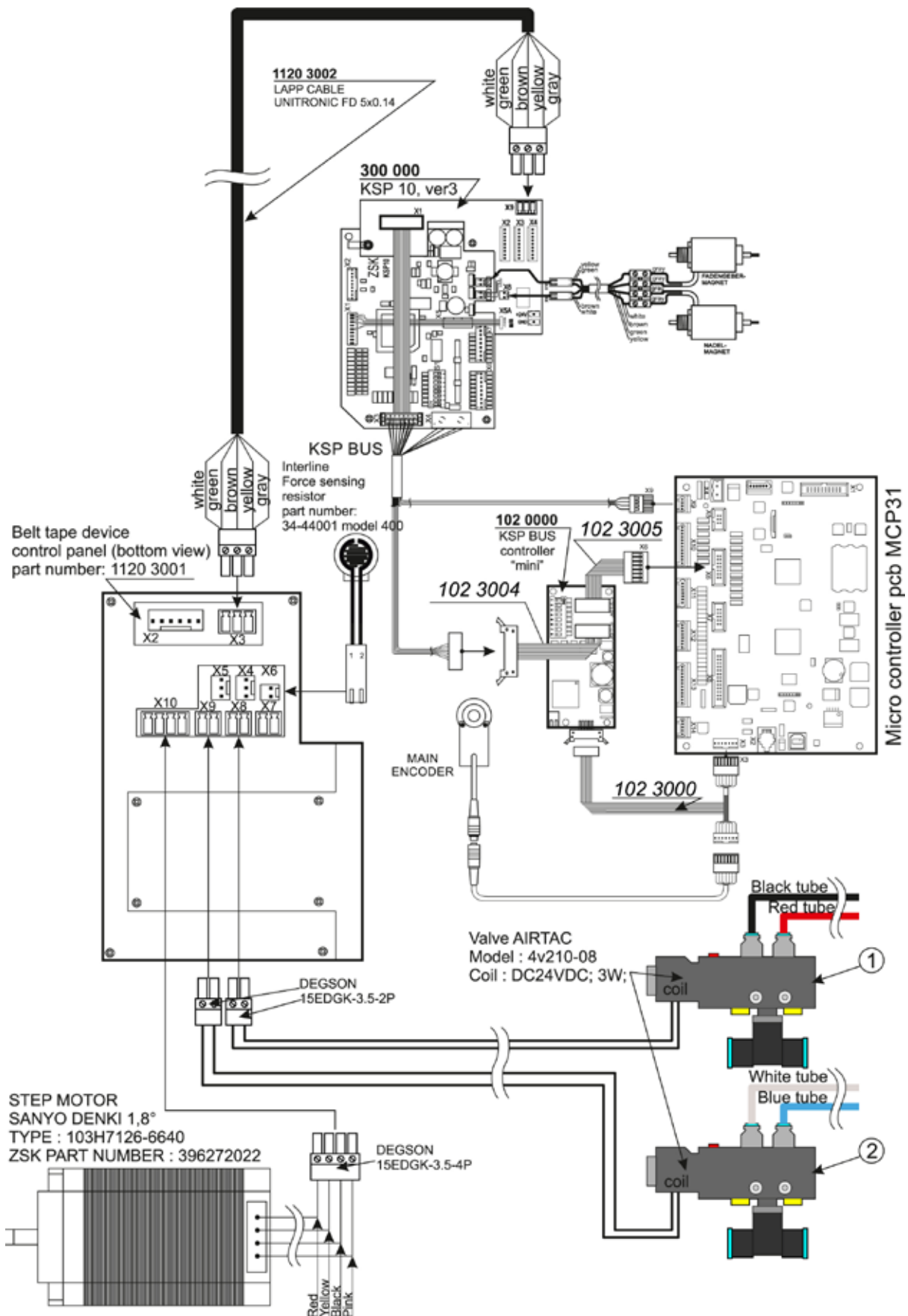

## 7.4 ROLL2BASKET(Part List)

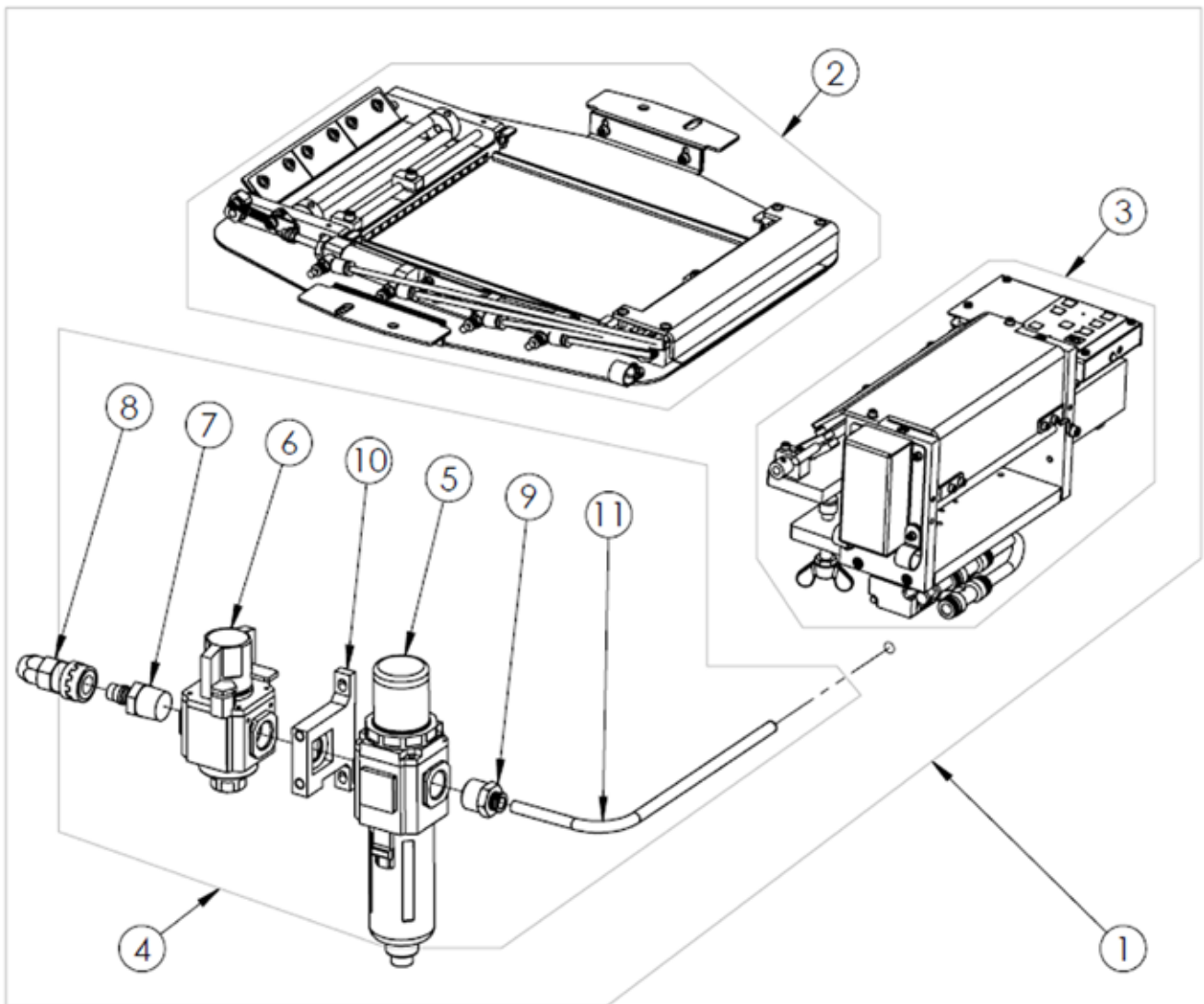

ITEM NO.	DESCRIPTION	PART NUMBER	QTY.
1	Roll 2 Basket (Assembly)	1100 0000	1
2	Embroidery Hoop Pneumatic (Assembly)	1110 0000	1
3	Tape Control Device (Assembly)	1120 0000	1
4	Air Preparation Unit (Assembly)	1130 0000	1
5	Filter-Regulator GFR30015F1G	1130 2053	1
6	On-Off Valve GZ30015G	1130 2054	1
7	Quick Coupler KK130P-04MS	1130 2135	1
8	Quick Coupler KK130S-80N	1130 2136	1
9	Male Straight Connector PC08-04	1130 2137	1
10	Joint Bracket GA300T-P1	1130 2138	1
11	Polyurethane Tube OD8 mm X ID5 mm X 1500 mm (Blue)	1130 2139	1

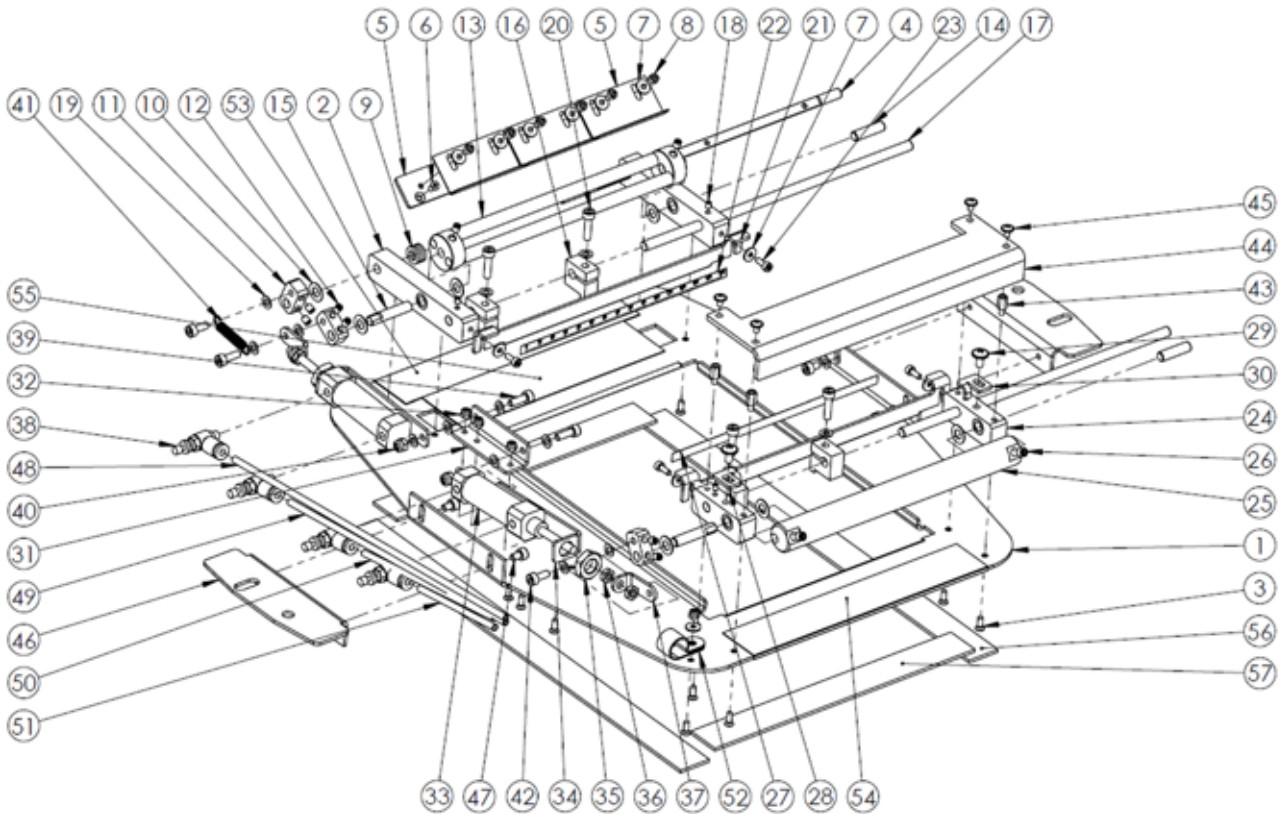

ITEM NO.	DESCRIPTION	PART NUMBER	QTY.
1	Base Plate 2	1110 1116	1
2	Bearing's Body Assembly	1110 1127	2
3	Countersunk Flat Head Cross Recess Screw M3x8 ISO 7046-1	0000 2154	12
4	Flat Clamping Axle	1110 1126	1
5	Flat Clamping Plate	1110 1142	4
6	Countersunk Flat Head Cross Recess Screw M3x6 ISO 7046-1	0000 2165	3
7	Plain Washer Large 3,2 DIN 9021	0000 2023	11
8	Hexagon Socket Head Cap Screw M3x5 DIN 912	0000 2008	6
9	Plain Washer Small 6,4 DIN 433	0000 2017	4
10	Shim Ring 6x12x0,5 DIN 988	0000 2170	7
11	Shackle	1110 1120	3
12	Hexagon Socket Set Screw Flat Point M4x5 DIN 913	0000 2015	8
13	Tensioning Mechanism Fork	1110 1117	1
14	Axle 6	1110 1118	2
15	Axle 6x31	1110 1119	2
16	Regulator 1	1110 1122	4
17	Axle 6x205	1110 1121	2
18	Hexagon Socket Head Cap Screw M3x4 DIN 913	0000 2167	4
19	Plain Washer Small 4,3 DIN 433	0000 2081	19
20	Hexagon Socket Head Cap Screw M4x16 DIN 912	0000 2029	4
21	Tape Clamp Lath	1110 1132	2
22	Ruller Strip 0-200 mm	1110 1133	1



ITEM NO.	DESCRIPTION	PART NUMBER	QTY.
23	Hexagon Socket Head Cap Screw M3x8 DIN 912	0000 2008	4
24	Bearing Short Body Assembly	1110 1128	2
25	Front Clamping Shaft	1110 1129	1
26	Hexagon Socket Set Screw Flat Point M5x5 DIN 913	0000 2082	2
27	Ruller Strip 200-0 mm	1110 1151	1
28	Detent Left	1110 1134	1
29	Pan Head Cross Recess Collar Screw M4x8 DIN 967	0000 2166	2
30	Detent Right	1110 1135	1
31	Support Corner	1110 1125	1
32	Prevailing Torque Type Hexagon Nut M3 ISO 7040	0000 2171	4
33	Air Cylinder	1110 2164	2
34	Air Cylinder Corner	1110 1124	2
35	Hexagon Thin Nut M10x1 DIN 439	0000 2169	2
36	Hexagon Thin Nut M5 DIN 439	0000 2168	4
37	Air Cylinder Brace	1110 1137	2
38	Air Flow Speed Controller	1110 2028	4
39	Hexagon Socket Head Cap Screw M4x12 DIN 912	0000 2005	3
40	Prevailing Torque Type Hexagon Nut M4 ISO 7040	0000 2040	2
41	Tension Spring	1110 1123	1
42	Hexagon Socket Head Cap Screw M4x10 DIN 912	0000 2006	2
43	Standoff 5xM3x8 Male-Female	0000 2088	4
44	Protection Cover 1	1110 1131	1
45	Pan Head Cross Recess Collar Screw M3x5 DIN 967	0000 2011	4
46	Attachment Plate	1110 1115	2
47	Hexagon Socket Head Cap Screw M4x6 DIN 912	0000 2167	4
48	Polyurethane Tube OD4xID2,5 mm (Clear)	1110 1138	1
49	Polyurethane Tube OD4xID2,5 mm (Blue)	1110 1152	1
50	Polyurethane Tube OD4xID2,5 mm (Orange)	1110 1153	1
51	Polyurethane Tube OD4xID2,5 mm (Black)	1110 1154	1
52	Cable Clamp 13	0000 2158	1
53	Adhesive Leather Tape 180x50	1110 1140	1
54	Adhesive Rubber Tape 180x50	1110 1139	1
55	Adhesive Rubber Tape 155x40	1110 1141	1
56	Long Sliding Strip	1110 1143	2
57	Short Sliding Strip	1110 1144	2

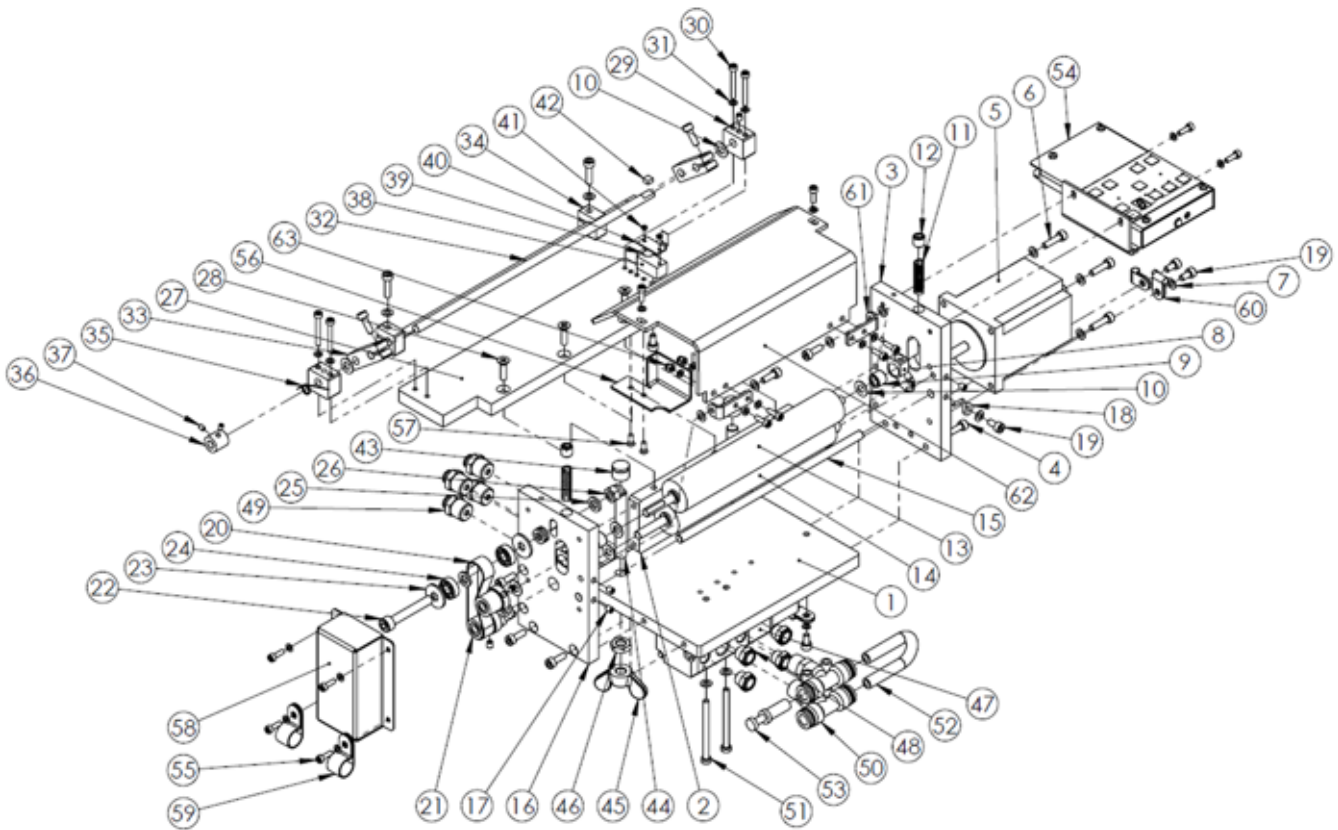

ITEM NO.	DESCRIPTION	PART NUMBER	QTY.
1	Clamp Cheek 2	1120 1099	1
2	Clamp Joint	1120 1096	1
3	Motor Base	1120 1088	1
4	Hexagon Socket Head Cap Screw M4x12 DIN 912	0000 2005	12
5	Step Motor	1120 4004	1
6	Hexagon Socket Head Cap Screw M4x16 DIN 912	0000 2029	6
7	Plain Washer Small 4,3 DIN 433	0000 2007	15
8	Block	1120 1091	2
9	Needle-Bearing HK 0608 SKF	1120 2150	3
10	Shim Ring 6x12x0,5 DIN 988	0000 2170	7
11	Compression Spring	1120 1092	2
12	Hexagon Socket Set Screw Flat Point M8x8 DIN 913	0000 2145	2
13	Feed Roller	1120 1102	1
14	Drive Roller	1120 1103	1
15	Axle	1120 1097	1
16	Reducer Base	1120 1089	1
17	Hexagon Socket Set Screw Flat Point M4x5 DIN 913	0000 2015	7
18	Reducer Cover Detend	1120 1093	1
19	Hexagon Socket Head Cap Screw M4x8 DIN 912	0000 2012	5
20	Timing Belt	1120 2140	1
21	Pulley	1120 1090	2
22	Hexagon Socket Head Cap Screw M6x40 DIN 912	0000 2146	1

ITEM NO.	DESCRIPTION	PART NUMBER	QTY.
23	Plain Washer Large 6,4 DIN 9021	0000 2147	2
24	Single Row Radial Contact Ball Bearing 696-2RS DIN 625	1120 2151	2
25	Plain Washer Small 6,4 DIN 433	0000 2014	5
26	Domed Cap Nut M6 DIN 1587	0000 2149	1
27	Clamp Cheek	1120 1100	1
28	Countersunk Flat Head Cross Recess Screw M4x16 ISO 7046-1	0000 2085	3
29	Prism	1120 1094	2
30	Hexagon Socket Head Cap Screw M3x25 DIN 912	0000 2144	4
31	Plain Washer Small 3,2 DIN 433	0000 2009	21
32	Axle 6x235	1120 1109	2
33	Shackle 2	1120 1108	2
34	Regulator 2	1120 1107	2
35	Torsion Spring	1120 1098	1
36	Torsion Spring Clamp	1120 1106	1
37	Hexagon Socket Set Screw Flat Point M3x4 DIN 913	0000 2081	2
38	Force Sensor Abut	1120 1105	1
39	Force Sensor	1120 2142	1
40	Force Sensor Plate	1120 1112	1
41	Pan Head Cross Recess Screw M2x6 ISO	0000 2153	2
42	Magnet 5x5x3	1120 2141	1
43	Thrust Pad	1120 1114	2
44	Double-End Bolt M8x50	0000 2160	2
45	Rounded Wing Nut M8 DIN 315	0000 2159	2
46	Chamfered Hexagon Thin Nut Style M8 DIN 24035	0000 2156	2
47	Solenoid Valve	1120 2152	2
48	Flat Silencer	1120 2161	4
49	Male Straight Coupler 4	1120 2155	4
50	Male Straight Coupler 8	1120 2162	2
51	Hexagon Socket Head Cap Screw M4x55 DIN 912	0000 2143	2
52	Polyurethanes Straight Tubing 8	1120 1113	1
53	Plug	1112 2163	1
54	Control Panel R2B-CP	1121 0000	1
55	Hexagon Socket Head Cap Screw M3x10 DIN 912	0000 2020	12
56	Cable Protection	1120 1111	1
57	Countersunk Flat Head Cross Recess Screw M3x8 ISO 7046-1	0000 2154	2
58	Reducer Cover	1120 1104	1
59	Cable Clamp 13	1120 2158	2
60	Cable Clamp 5	1120 2157	3
61	Hinge	1120 1101	2
62	Reducer Cover	1120 1095	1
63	Domed Cap Nut M3 DIN 1587	0000 2148	4

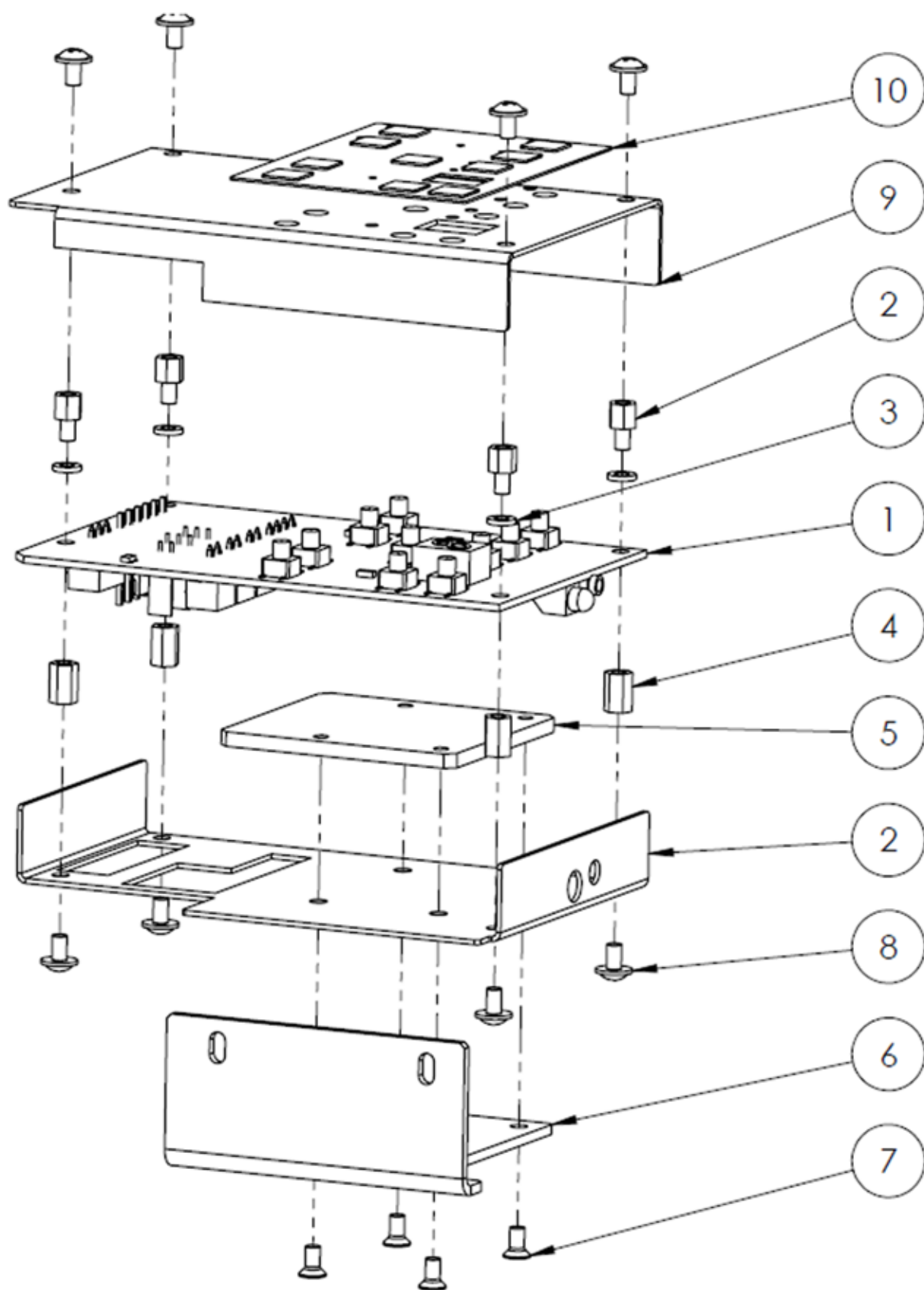



---

<b>ITEM NO.</b>	<b>DESCRIPTION</b>	<b>PART NUMBER</b>	<b>QTY.</b>
1	Control Panel Board	1121 3016	1
2	Standoff 5xM3x5 Male-Female	1121 2004	5
3	Shim Ring 3x6x1 DIN 988	1121 2009	4
4	Standoff 5xM3x8 Female-Female	1121 2172	4
5	Radiator Aluminum	1121 1148	1
6	Control Panel Attachment Corner	1121 1146	1
7	Countersunk Flat Head Cross Recess Screw M3x6 ISO 7046-1	0000 2165	4
8	Pan Head Cross Recess Collar Screw M3x5 DIN 967	0000 2011	8
9	Control Panle Cover	1121 1145	1
10	Control Panle Label	1121 1147	1

## **ZSK Stickmaschinen GmbH**

Magdeburger Str. 38- 40  
47800 Krefeld  
Germany

Online: [www.zsk.de](http://www.zsk.de)

Email: [zsk@zsk.de](mailto:zsk@zsk.de)



[facebook.com/zsk.stickmaschinen](https://facebook.com/zsk.stickmaschinen)



[youtube.com/zskfilm](https://youtube.com/zskfilm)

# ZSK - DIE STICKMASCHINE.